

METREX

*Digital instrument for detecting gas leaks.
For professional use only*



Contents

EU Declaration of conformity	4
Warnings ATEX.....	5
General Description.....	6
Safety Instructions	6
User Interface	7
Overview of the instrument.....	7
Connections	7
Display	8
Navigation System (menu).....	9
Logogram of the scroll menu.....	10
Instrument functions.....	11
Switch On	11
Switch OFF	12
Instrument functions (continued)	12
Use of GPS.....	12
GPS Activation.....	12
GPL/LPG/GLP measurement (OPTIONAL)	13
Saving leaks.....	13
Delete data.....	13
Viewing Data.....	14
On/Off Vol Lock	14
Description of the pneumatic circuits	14
Pneumatic circuit / Pump OFF	15
Restarting the pump.....	16
Ending the leak detection	16
Manual Zeroing.....	16
Alternative sensor view.....	16
Alarm Settings.....	17
Option 1	17
Option 2	18
Over-Range	18

Backlight - Display brightness	19
Maintenance	20
Battery indicator and low battery warning	20
Recharging the Battery Pack	20
Replacing the Battery Pack	22
Replacing the Hydrophobic Filter	23
Bump Test	25
Calibration	25
Alarms and Error Information	25
Resetting the alarms:	26
Warranty	27
APPENDIX A – Safe Use of The Instrument	28
Other precautions for the usage	28
Testing and maintenance	28
Repair	28
Conformity	29
APPENDIX B – Technical Specifications	30
Additional Accessories and Performance	31
APPENDIX C - Information On Disposal For Users Of Waste Electrical & Electronic Equipment	32
APPENDIX D – Bluetooth Module Compliance	33
United States	33
Canada	33
Europe	34

EU Declaration of conformity



EU Declaration of Conformity

This Declaration of Conformity is issued under the sole responsibility of the manufacturer:

QED Environmental Systems
Cyan Park – Unit 3
Jimmy Hill Way
Coventry
CV2 4QP
UNITED KINGDOM

Product: METREX product range

Type of equipment: The Metrex instrument is designed for pre-localisation, localisation and classification of natural gas leaks.



The METREX described above is in conformity with the relevant Union harmonisation legislation:

2014/34/EU: Equipment and protective systems intended for use in potentially explosive atmospheres (ATEX)

TÜV Italia (0948) performed assessment against:

- EN IEC 60079-0:2018
- EN 60079-11:2012
- EN 60079-1:2014
- EN 60079-29-1:2016
- EN 50271:2018

Issuing certificate number TÜV IT 20 ATEX 044 X

2014/53/EU: Radio equipment (RED)

EMC (Article 3.1.b) and Radio Spectrum (3.2):

- EN 301 489-1
- EN 301 489-17
- EN 301 489-19
- EN 61326-1:2012

Signed for and on behalf of:

Name: Mr. Craig Millar
Position: Engineering Manager
Done at: QED Environmental Systems
On: 8th March 2022

www.qedenv.com

MISO201-METREX Iss.02
© QED Environmental Systems Ltd.



Warnings ATEX

The operating manual must be read and fully understood before using the equipment
This warning is in place so that the operator fully understands the product and its use within the application.

Battery must be replaced in a non-hazardous, safe area

Use only with battery pack QED PBLO

Battery pack QED PBLO must only be used with QED METREX.

Do not charge the device in a hazardous area OR only charge in a non-hazardous, safe area

Battery charging and communication (USB) must only be done in a non-hazardous, safe area with adapter QED CCLO.

Use only this device to charge QED METREX.

Maximum voltage $U_m \leq 15V$

The maximum voltage that can be applied to the external adapter QED CCLO to charge QED METREX and without invalidating the type of protection is 15 volts.

Do not connect the METREX, the battery pack PBLO and adapter CCLO to other equipment.

These three devices are only designed to be used together to ensure the correct functionality of the device and guarantee the safety of the operator.

Do not open the device

Only the manufacturer or its authorised representatives can open the device for maintenance and repair. Unauthorised opening of the device invalidates the integrity, certification and guarantee of the product.

Special conditions for safe use

- The equipment is intended to be used in ambient temperatures range from $-30^{\circ}C$ to $+50^{\circ}C$.
- The equipment shall exclusively be used with the battery pack QED type PBLO. Replacement of this battery pack shall be performed in non-hazardous area.
- Charge and data communication shall be performed in non-hazardous area by the appropriated accessory QED type CCLO.

General Description

The METREX is the latest generation portable gas detection instrument which can be used for the systematical survey of natural and town gas networks and leak detection and localisation inside and outside buildings. Benefits include:

- Accurate and rapid response of Methane (CH₄) and Propane (C₃H₈) in the concentration range of ppm, %LEL and %Volume (utilising semiconductor, pellistor pair and volumetric thermal conductivity pair sensor technology).
- Large backlit LCD display, in a lightweight and rugged water-resistant (IP 65) design.
- Improved battery life and user changeable battery pack for less downtime.
- ATEX Certified for use in hazardous areas.
- Inbuilt ATEX GPS and Bluetooth, enabling the storing of surveying routes including leak location and easy data transfer whilst in the field.
- A wide range of probe accessories to suit every application.

METREX has been certified with the intrinsic safety protection mode and has obtained the following marking:

 II 2 G Ex db ib IIB T4 Gb
EN 60079-29-1

Safety Instructions

It is the responsibility of the owner of the equipment to ensure that all personnel are adequately trained and the equipment is serviced and maintained in accordance with the applicable code of practice and this operating manual.

It is the responsibility of the owner to ensure that all personnel are adequately trained in the safety aspects of the gases being surveyed and appropriate procedures are followed.

The equipment should not be altered in any way other than described within this operating manual. Alterations or changes outside of this operating manual could make the equipment unsafe and invalidate the hazardous area certification.

Repair and maintenance of this equipment should be carried out in accordance with the applicable code of practice and this operating manual. Only QED approved components are to be used with this equipment.

User Interface

Overview of the instrument

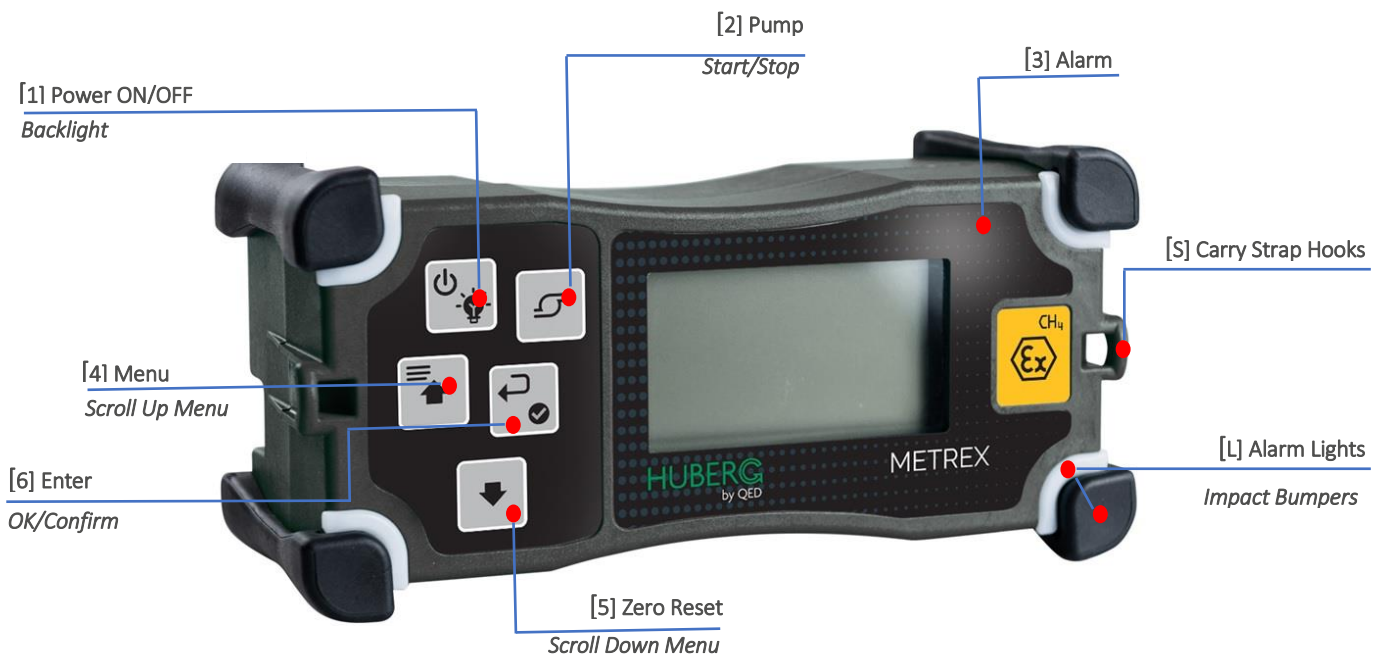

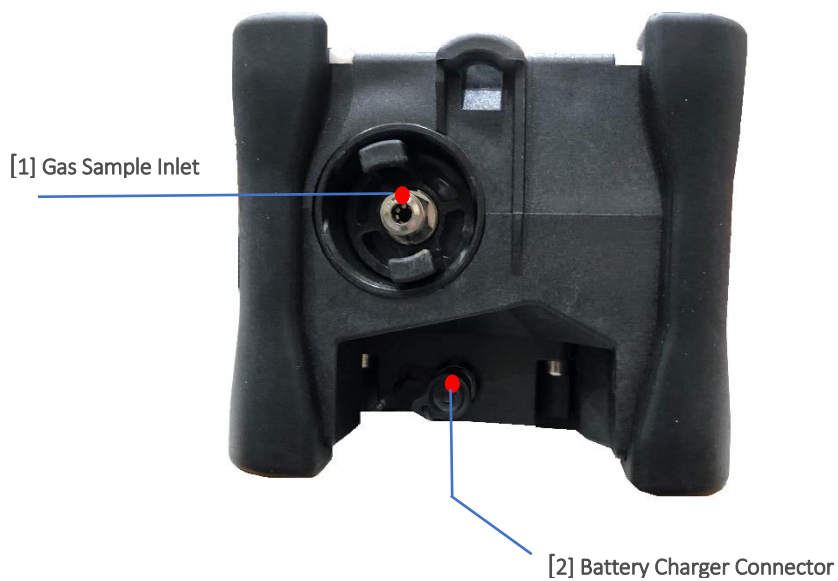

Connections

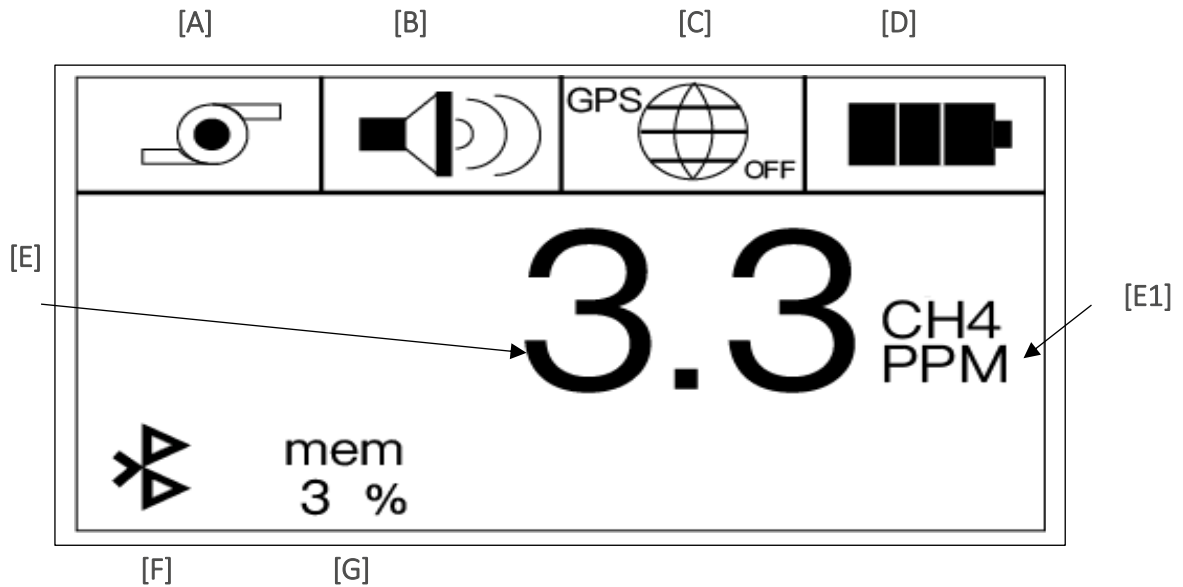

Note: Images are for representative use only

Display



Sector	Function / Description	Present in all METREX Versions
[A]	Pump Status	Yes
[B]	Alarm Buzzer Status	Yes
[C]	GPS Status	No
[D]	Battery Status	Yes
[E]	Measured Gas Level	Yes
[E1]	Measurement Scale: PPM (parts per million) - % VOL (volume)	Yes
[F]	Bluetooth Connection with PC Note: this icon  PC indicates that the instrument is connected to a PC. Data will be saved to the PC and not to the instrument.	No
[G]	Memory used	Yes

Navigation System (menu)

Push the “Menu” button  and the menu will appear in the display window [E].

Use the up and down arrow keys to scroll through the available menu options. Once you have identified your

desired option, push the “OK”  button to confirm your selection.

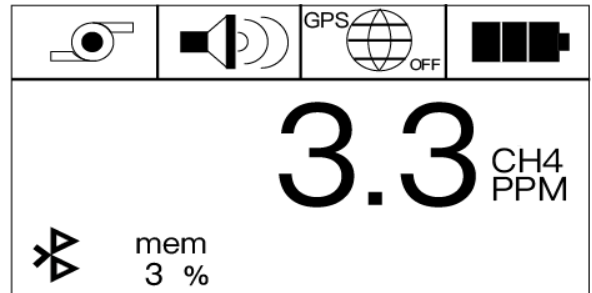

While a menu is active, the gas value is displayed in the upper right corner of the display [D].

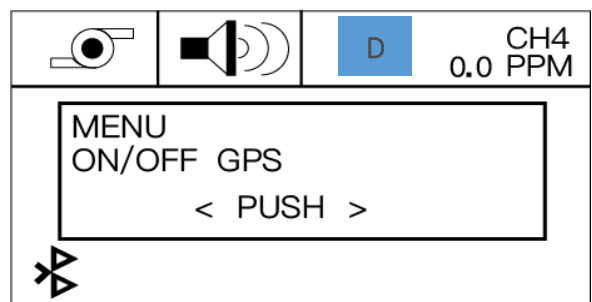

Select “ESC” to exit the Menu

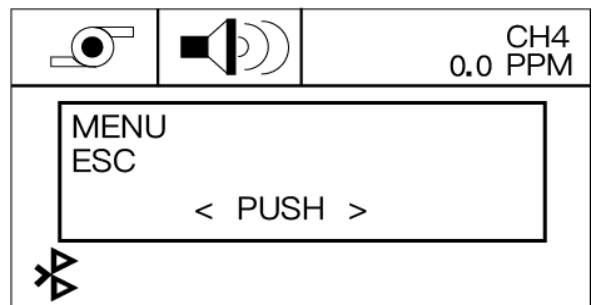

Logogram of the scroll menu.

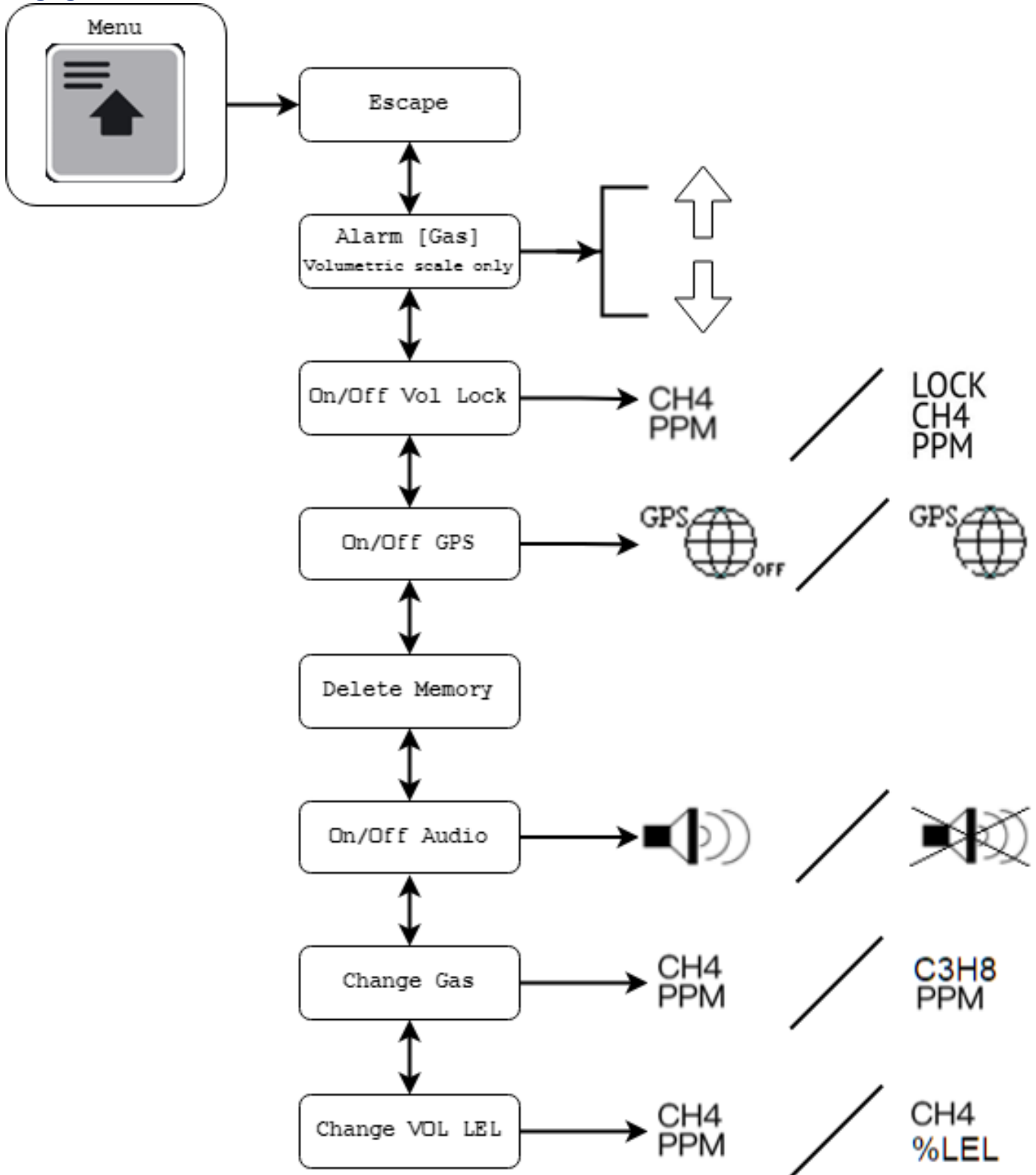

Instrument functions

Switch On

Press the ON/OFF button [1] for few seconds, until the display is activated.

The start sequence includes several steps:

- - Huberg by QED Logo
- - Information about the firmware version of the instrument, serial number of the instrument and the date of the next calibration
- - Date, time and next calibration

The instrument will warm up and self-calibrate. The warm up will last approximately 30-seconds and during this time, the instruments functions are not available for use.

Once the warm up and calibration are complete, the four LED lights will blink and the alarm will sound.



WARNING: Turn the analyser on in a gas-free area to ensure self-calibration is not affected.

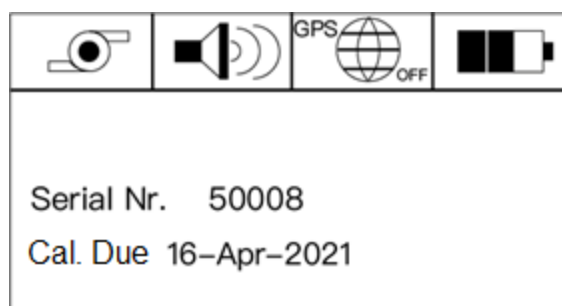
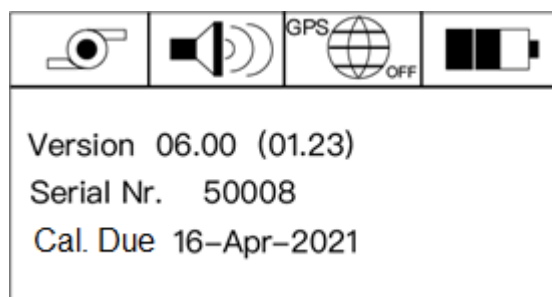

Switch OFF

To switch off the instrument, press and hold the ON/OFF button [1] for a few seconds. A message will appear on the display and will count down until the Metrex powers off.

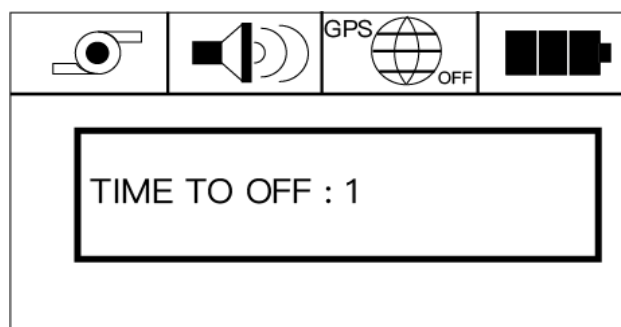

Instrument functions (continued)

Use of GPS

After switching on the instrument, the GPS is not active.

The GPS allows the user to save the value of the associated gas at the current GPS. The memory capacity of the instrument, allows a full day of measurements to be recorded, this is typically up to 10 hours. The GPS information is stored every second.

NB: ---- % means that the instrument is not logging.

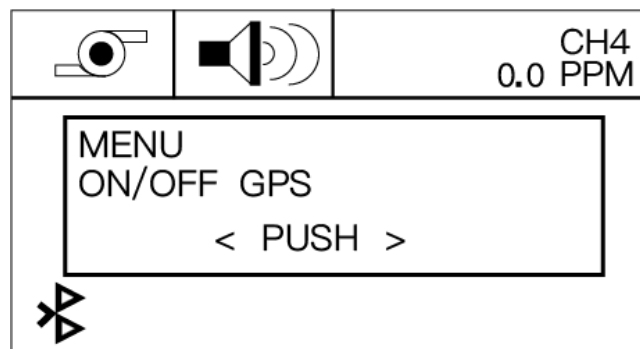
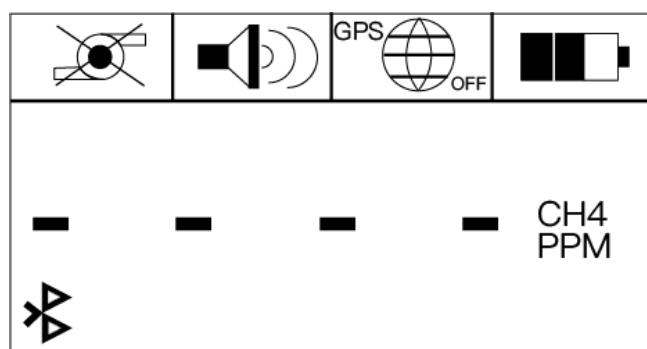

GPS Activation

To activate the GPS, press the “Menu” button [4] and Use the up and down arrow keys to scroll through the menu options until “ON/OFF GPS” appears. Press the “OK” button to confirm the selection. The GPS icon will change status from “Off” to “Active”.

ICON	DESCRIPTION
	GPS Off
	GPS active and searching for signal

The GPS module is a high-performance receiver integral to the Metrex that maintains the ATEX certification, which has the ability to track up to 20 satellites. The antenna is a standard, high gain, vehicular type that provides quality tracking performance.

Start-up time for the GPS module can vary according to the strength of the actual signal received. The presence of high trees or buildings, aerial power lines or other obstructions will affect the signal. Typically, in an open area, the GPS will fix in less than a minute.

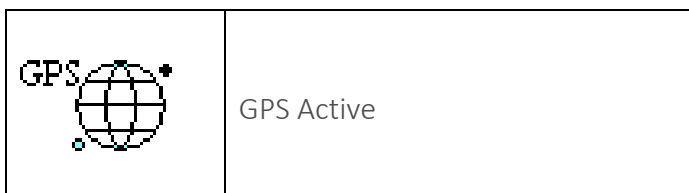

In the event of signal loss during the survey, the instrument will continue to log gas values, and will associate these with the last saved tracked GPS position.

GPL/LPG/GLP measurement (OPTIONAL)

The METREX can be calibrated for CH₄ and/or GPL (C₃H₈).

Note: Liquefied petroleum gas is also known as LPG, GPL, GLP or Autogas depending on geographical location

WARNING: gas type selection must be completed in a gas-free area

The gas type can be switched during normal operation of the instrument. Switch the gas type by pressing the “Menu” button [4] and pressing the up or down arrows until option CHANGE GAS is displayed and then press the ‘Enter’ button [6]. The gas type text to the right of the gas reading will switch between CH₄ and GPL, indicating the Metrex is now ready to measure the new gas type.

Saving leaks

To save a leak into the memory of the instrument, hold the “Enter” button [6] for 2 seconds. Alternatively, push the “Menu” button, and use the up or down arrows until the option “Save Leak” appears. Push the “OK” button to save the leak. When the memory is full, the word ‘full’ will be displayed next to ‘mem’.

Note: Data is only captured and saved when the GPS is on.

Delete data

To delete the GPS and saved leak data stored in the instrument, push the “Menu” button [6] and use the up and down arrow keys until the menu displays DELETE MEMORY. Press the “Enter” button [6] to confirm the selection.

Note: Deleted data cannot be recovered

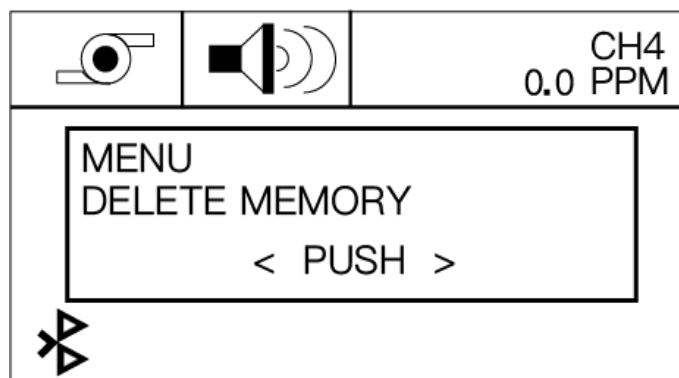

Viewing Data

Stored data can only be viewed after being downloaded to the PROSoft Software Application. Data can be transferred using Bluetooth or USB.

Live readings cannot be viewed over the Bluetooth or USB communications as part of the normal gas detection operation.

On/Off Vol Lock

By default, this option is enabled. This is evident from the word LOCK above the gas name on the reading screen at all times.

When the gas concentration exceeds 10,000ppm (1%) the METREX will automatically switch from ppm to %vol mode and the blue LED bumper visual alarm will be ON. With VOL LOCK enabled, the METREX will latch in %vol mode, and will not automatically return to ppm mode when the concentration decreases below 0.1%vol.

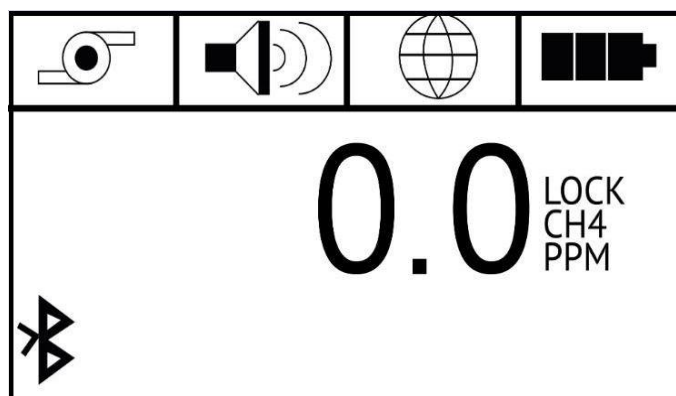

When the concentration drops back below 0.1%VOL, the blue LED bumper remains ON to indicate that the METREX remains in %VOL mode. To return to ppm mode, press the down arrow/0 key when the concentration is less than 1.0%.

Zeroing the reading is still completed by pressing the down arrow/0 key, whilst the METREX is both in ppm mode and has a ppm reading of less than 100ppm.

To toggle the VOL LOCK mode, press the menu key, scroll to the ON/OFF VOL LOCK option and press the OK key.

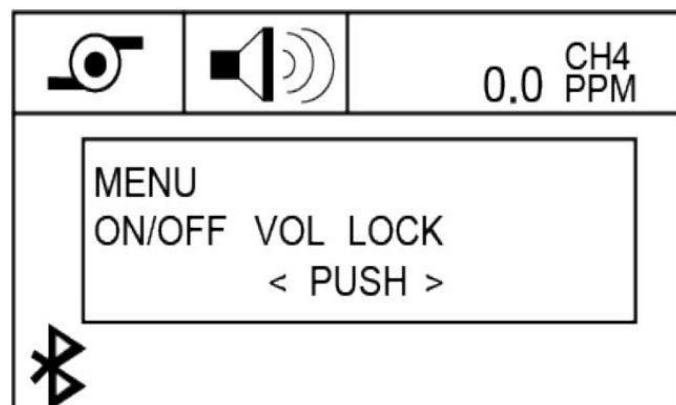

Description of the pneumatic circuits

The device operates in sampling mode utilising its integral membrane pump. The typical flow is 0.8 l/m and the minimum flow is 0.6 l/m. To ensure a good flow rate is maintained, the sample tubing should not be altered in any way unless authorised by QED. The maximum flow is 1 l/m.

It should be noted that the use of accessories, such as the probe, can slightly reduce this flow. It is then advised to only use the parts and accessories supplied by QED.

The gas inlet port size is D2 X D4 mm.

An internal hydrophobic filter protects the device against dust or water. External filters should be used at all times during the instruments use in order to further protect the internal filter from the ingress of moisture or dust particles. Spare filters are available. Part No: H-2012272

Note: The filter is not designed to protect against chemicals.

WARNING: Care must be taken to avoid water or dirt being drawn into the instrument as this may cause malfunction to the pneumatic circuit and can seriously damage the sensors.

Pneumatic circuit / Pump OFF

The instrument monitors the pump flow, if the flow rate is reduced by a blockage as a result of moisture or dust particles, the pump will stop. The LEDs will light, the pump icon will be overlaid with a cross and the message "PUMP ERROR" is displayed.

The pump can be manually turned off by pressing the pump button [2].

The pump will again be overlaid with a cross.

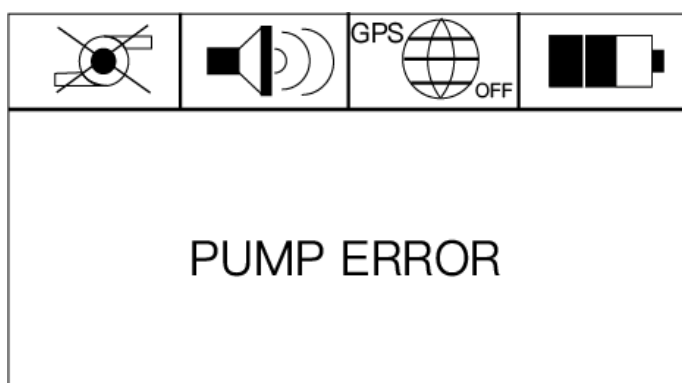

When the pump is off, the display shows four horizontal lines "- - - -". (these lines also appear in the hydrocarbons section).

Note: If the pump operation is suspended or interrupted, the instrument will stop logging. Adjacent to the % of memory, horizontal lines will be displayed "- - - -".

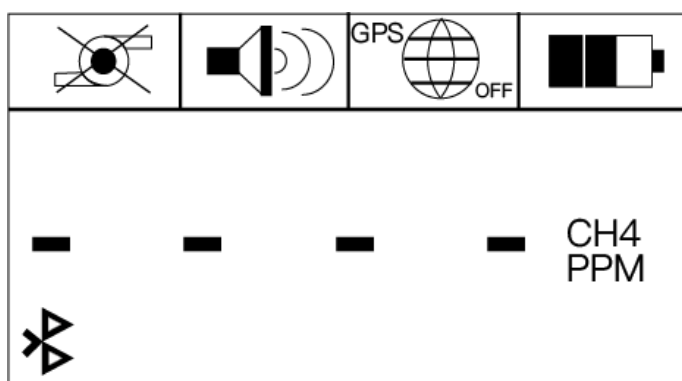

Restarting the pump

To turn on the pump again, press the pump button [2]; the cross overlay on the pump icon will disappear and the pump will restart.

Ending the leak detection

To end the detection, manually stop the GPS or turn the instrument off.

Manual Zeroing

A zero-gas calibration can be completed during operation. This can improve leak detection by ensuring the METREX is correctly reading zero before surveying, or to offset against background levels of gas present in the atmosphere, therefore it is highly recommended.



To perform a zero-gas calibration, press and hold the down arrow button until the reading is set to 0ppm



WARNING: zero gas calibration must be done in a gas-free area. The current reading must be under 100ppm in order to carry out a zero calibration.

Alternative sensor view



To change to the alternative sensor view, press and hold the 'pump' key for 2 seconds. To return to the standard view, press and hold the same pump key for 2 seconds. This will display %LEL and any other gas sensors fitted.

		GPS OFF	
---	%LEL CH4	NOT PRES	
NOT PRES		NOT PRES	

Alarm Settings

The METREX supports two alarm types:

Option 1: User configurable alarms for ppm/VOL (100 - 1,000,000ppm)

Option 2: Two fixed alarms at 10% LEL and 50% LEL

Option 1

The alarms limit can be changed in PPM scale: the minimum permissible limit is 100ppm and the maximum permissible limit is 1,000,000ppm (100%).

Pushing the “Menu” key [4], will display the menu options. Use the up and down arrow keys to scroll to “CH4 Alarm”, select this using the “Enter” button [6].

Whilst in this menu option, change the ppm limit using the up and down arrow keys. To confirm the desired level, press the “Enter” button.

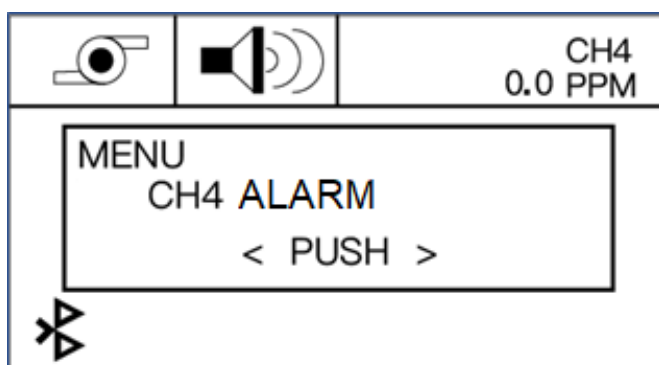

When the measured gas concentration has exceeded the alarm threshold, the red LED's will illuminate and the acoustic alarm will sound.

The audible alarm can be enabled or disabled by using the ON/OFF AUDIO menu option and pressing the “OK” button. When the audible alarm is disabled, the alarm icon is overlaid with a cross and the LEDs will continue to illuminate.

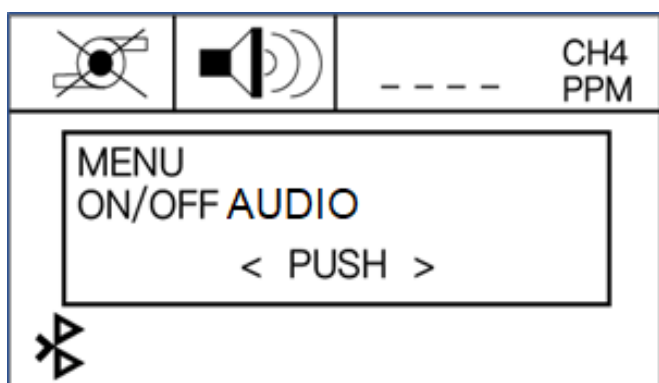

Option 2

The alarms thresholds cannot be adjusted by the user.

When the measured gas concentration has exceeded the 10% LEL alarm threshold, the red LED's will illuminate with a low brightness and the acoustic alarm will sound.

If the measured gas concentration exceeds the 50% LEL alarm threshold, the red LED's will illuminate with a high brightness and the acoustic alarm will sound with a pulsing tone.



The audible alarm can be enabled or disabled by using the ON/OFF AUDIO menu option and pressing the "OK" button. When the audible alarm is disabled, the alarm icon is overlaid with a cross and the LEDs will continue to illuminate.

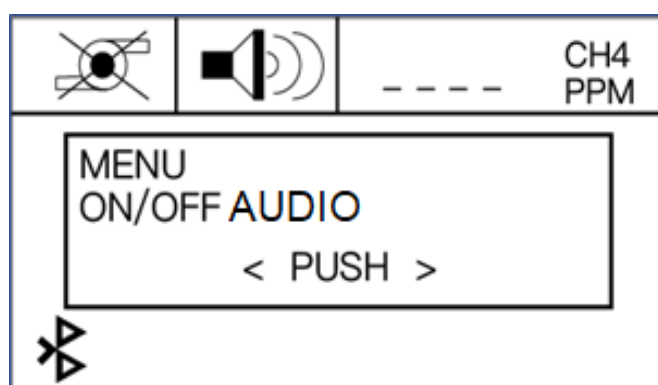

Over-Range

If a reading is over-range (i.e. above the maximum allowed value) it will display more than chevrons (>>>):

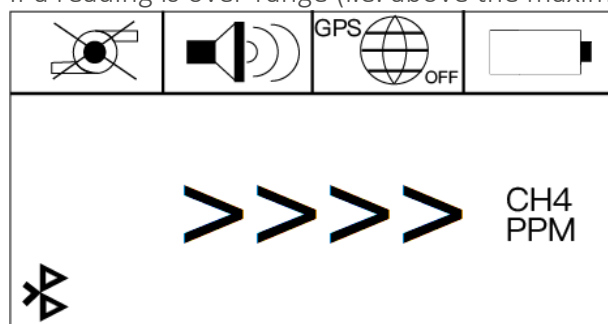

If this problem occurs, first, fresh air purge the instrument and follow the manual zeroing function. If the problem persists, please contact technical@qedenv.co.uk / service@qedenv.com.

Backlight - Display brightness



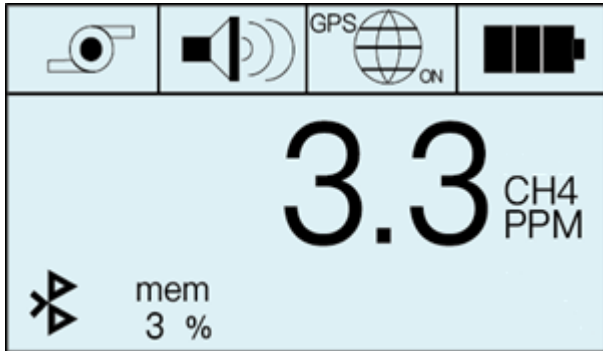



To change the display brightness, push button [1] until you reach the desired level. The display has 4 levels of brightness. (Off – Low – Medium - High)



Maintenance

Battery indicator and low battery warning

The battery status indicator shows four states of capacity:

Icon	Description
	Fully charged
	66% charge remaining
	33% charge remaining
   	Battery is empty and instrument will turn off in several seconds

Recharging the Battery Pack

The METREX is supplied with a rechargeable battery pack (PBLO.NNNN.YY 3.7V 4Ah). The charging of the battery is done only using the external adapter CCLO and the power supply. Connect the charger with the power supply according to the figure below, using the two polarity connectors in conformity with the maximum authorized voltage (Um equal to 15V).

The item listed below are the only components that are to be used with the Metrex instrument.

- Rechargeable battery pack lithium ion (PBLO.NNNN.YY 3.7V 4000mAh) (Part No:H-102049)
- Charging adapter (CCLO.NNNNN.YY) Part No : H-M4-S001 or H-M4-S002
- Power supply for use with Charging adapter (Um<15 volts)
- Car cable power supply (Part No: H-102010)

NOTE: There are two charging adapters available

H-M4-S001 – This adapter is not only used for charging but also has a built in USB port for data communications.

H-M4-S002 – This adapter is for charging only without the communications option.

Connect the charger with the power supply in accordance to the adjacent figure using the two-pole connector.

Note: ensure the white dots on each connector are aligned

The typical operational time of the Metrex is 10 hours at ambient temperature with the backlight and pump 'on'. This operational time will be affected by changes in ambient temperature and also if the backlight is turned off.

The typical charge time is 4.5hours.

NOTE:

Red LED on charger indicates Metrex is charging.

Green LED on charger indicates Metrex is fully charged.

The battery technology is Lithium ion. This battery pack is not restricted according to the European and international regulations for dangerous goods.

Therefore, this battery can be transported by plane following the requirements of the labelling of the package.

The battery charge level is indicated on the main display. There are three levels of charge indicated.

The lowest tier of charge indicates 30 minutes of operation (@ 20°C).

The duration of the complete charge cycle is typically 4 hours 30 min.

The red LED on the charger indicates that the instrument is charging.

When the charge cycle is complete, this LED will change to green.

NOTE: Do not attempt to charge the battery when the ambient temperature is below 0°C / 32°F.

Advice about the use of lithium ion technology:

In order to optimize the use and the lifetime of your battery, please, follow the following guidelines:

- Charge the battery within an ambient temperature between the range +10° to +30°C
- Allow the battery to reach a complete discharge as frequently as possible
- Store in a dry place at a temperature preferably not exceeding 30°C
- Store in a dry place at a temperature preferably not exceeding 30°C

Central supply connector – Um=15v.



USB 1 Power Supply USB 2

NOTE: USB 1 is for data transfer
 USB 2 is for factory use only



WARNING: Only charge in a non-hazardous, safe area

Replacing the Battery Pack

Note: Pictures are for representative use only.

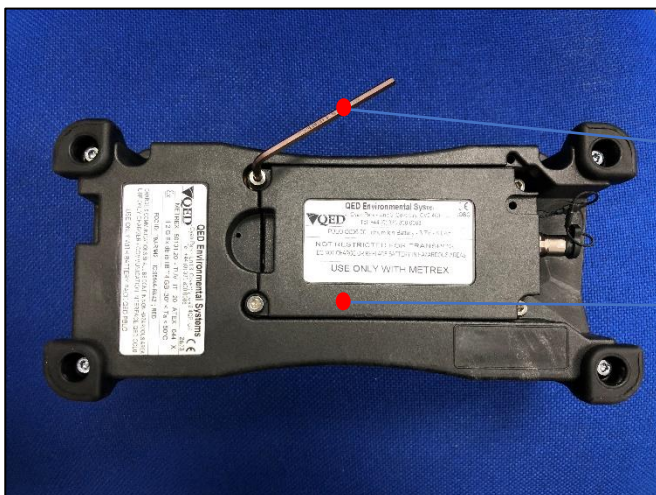

ALLEN KEY 3mm



ATEX Battery Pack



Unscrew the four battery screws



Battery pack removed from instrument

 **WARNING:** Replace the battery pack only in a non-hazardous, safe area

Replacing the Hydrophobic Filter



To remove the filter, rotate the filter assembly counter clockwise. The filter then unplugs from its housing.

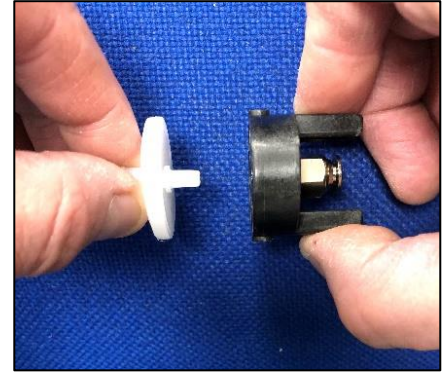

Once the filter has been replaced, re-assemble by rotating the filter assembly clockwise



Replacement filter Part No: H-201271
Replacement filter housing Part No:H-201283-GREY

The hydrophobic internal filter should be checked periodically, (recommended weekly during periods of heavy use).

Bump Test

The instrument can be tested with the 'bump test kit' comprising of:

- - A cylinder of CH₄ / C₃H₈ gas
- - A flow regulator 1l/min.

Bump Test Kit Part No: H-100157

Calibration

Other than when repair is required, it is recommended that the device is sent to an authorised 'Huberg by QED' distributor or directly to QED annually for inspection, maintenance, and calibration.

Details of local Huberg distributors can be obtained by visiting QED's distributor locator on www.qedenv.com

	Non-USA	USA
Tel:	+44(0)333 800 0088	(800) 624-2026
Address:	Unit 3 – Cyan Park, Coventry, UK, CV2 4QP	2355 Bishop Circle West, Dexter, MI. 48130, USA

Alarms and Error Information

The table below gives the different alarms and error information.

Displayed Alarm or Error	Error	Conditions
Acoustic alarm and the LED's flash	Gas alarm	Concentration measured above the alarm threshold.
The display shows the message ERROR PUMP, LED's flash and the pump icon is overlaid with a cross.	Pump stopped	The pump is stopped possibly due to the ingress of moisture or a high quantity of dust. -
Flashing battery icon	Battery level low	The lowest level of the charge capacity has been reached. There is approximately 30 minutes of use left (at +20°C)
LOW BATTERY message appears for a short duration	Battery level insufficient	The instrument is not able to work and switches off.
The display shows: no com from Sensors	Sensor fails to communicate properly	Turn the instrument off and on again. If the error persists, contact technical@qedenv.co.uk / service@qedenv.com

The bumper LED lights are used to indicate the following:

LED Bumper	Meaning
Red (top left/right)	Threshold concentration exceeded OR Battery low
Blue (bottom right)	measuring in the %VOL range



Resetting the alarms:

The table below indicates the alarm conditions, the audio / visual outputs and how the alarm can be reset.

Alarm and Information of default	Sound Alarm	LED indicator	Reset
Gas concentration threshold	✓ (if enabled)	✓	Yes, once below threshold
Pump stopped (flow fail)	x	x	Press pump key
Battery level low	✓	✓	Re-charge or replace battery

Warranty

The QED warranty terms and conditions for the Metrex can be found by using the link below:

[METREX Warranty Terms & Conditions](#)

APPENDIX A – Safe Use of The Instrument

The information contained in these safety instructions must be followed in addition to the warnings in the user manual supplied to the customer.



WARNING: Do not use the instrument METREX in a classified area if the version of the apparatus is not certified ATEX.

- It is recommended to the user to have knowledge of the Directive PPE (89/686/CEE) relative to the personal protective equipment.

It is advised to the user operating in ATEX area, to be equipped with a complete antistatic Personal Protection Equipment (PPE), in combination with conductive or dissipative ground, and shoes with a resistance below $10^8\Omega$, in agreement with the following regulation and standard: Regulation (EU) 2016/425 on personal protective equipment (PPE) to be applied as of 21 April 2018; EN 1127-1:2011 (Explosive atmospheres. Explosion prevention and protection - Basic concepts and methodology); the CLC/TR 50404:2003 “Electrostatics Code of practice for the avoidance of hazards due to static electricity”; IEC 60079-32-1:2013 and IEC 60079-32-1:2015.



WARNING: Do not open the device.

Other precautions for the usage

- The charging of the batteries must be in a safe place with the appropriate external adapter.
- The instrument is dedicated to measurements in ambient air or can accept gas mixture containing non-corrosive chemical products. In case of the presence of gas mixture except that hydrocarbon and neutral gases, contact your QED distributor to verify the compatibility with the device.

Testing and maintenance

The checks and maintenance of certified equipment should be performed according to the criteria of the standard EN60079-17.

Repair

In the event of malfunction or damage, please contact QED (or an authorised distributor) for support.

Conformity

The apparatus type METREX is usable in gas explosive atmosphere of group IIB and temperature class T4 for an ambient temperature from -30°C to +50°C.

The apparatus is category 2 and may be used in areas 1 and 2.

This equipment can contain gas sensing heads for the detection of particular gasses. The inclusion of a sensor does not infer that the equipment is suitable for the use of gases with temperature class of less than T4 and/or different from gas group IIB (or IIA) as reported in the marking.

The respect of essential safety requirements, defined in annex II of the 2014/34/ UE directive from 26th February 2014, is obtained by the apparatus conformity to the standards:

EN IEC 60079-0: 2018 Explosive atmospheres – Part 0: Equipment – General requirements

EN 60079-11:2012 Explosive atmospheres – Part 11: Equipment protection by intrinsic safety « i »

EN 60079-1:2014 Explosive atmospheres – Part 21: Equipment protection by flameproof enclosures "d"

EN 60079-29-1:2016 Explosive atmospheres – Part 29-1: Gas Detectors – Performance requirements of detectors for flammable gases

EN 50271:2018: Electrical apparatus for the detection and measurement of combustible gases, toxic gases or oxygen. Requirements and tests for apparatus using software and/or digital technologies

The following are applied to the apparatus:

Certificate number: TÜV IT 20 ATEX 044 X





Marking:  II 2 G Ex db ib IIB T4 Gb -30°C≤Ta≤+50°C
EN 60079-29-1

- II: 2nd group equipment intended for use in areas with an explosive gas atmosphere other than mines
- 2: Category two (suitable for installation in zone 1 and zone 2, not for zone 0)
- G: Only for gas, not for dust
- db: Flameproof protection method
- ib: Intrinsically safe protection method
- IIB: Gas group, only suitable for gases of IIA (e.g. Methane) and IIB (e.g. Ethylene)
- T4: Temperature class (max. surface temperature 135°C)
- Gb: Equipment protection level EPL, high protection
- EN 60079-29-1: Performance testing

APPENDIX B – Technical Specifications

Target gas	Methane (CH ₄), Propane (C ₃ H ₈)
Measurement ranges	1-10,000ppm 0-100%LEL 0.1% - 100% v/v
Minimum threshold	100ppm
Accuracy	+/-10% relative to reading
Response Time (T ₉₀)	8 seconds
Environmental working conditions	Temperature: -30°C to +50°C / -22°F to +122°F (in a non-condensing atmosphere) Pressure: Atmospheric pressure 800mbar to 1100 mbar / 23.62”Hg to 32.48”Hg Humidity: <95% relative humidity
Power supply	Specific Li ion rechargeable battery pack 3.7V – 4000mA/h Recharging duration: 4h30min
Charging Input	12Vdc 1.25A
Operational time	10 hours at 20°C / 68°F (with backlight activated)
Case	Carbon reinforced polyamide with fiberglass Dimensions: L x w x h = 230 x 97.5 x 110mm / 9.06” x 3.84” x 4.33” Weight: 1.3Kg / 2.9lbs (in operation)
Protection level	IP65
Environmental storage conditions (excluding batteries)	Humidity: < 95% relative humidity Temperature: -40°C to +60°C / -40°F to +140°C
Sampling flowrate	0.8 l/min / 800cc/min
User interface	Large Display: matrix of 86mm x 47mm / 3.39” x 1.85” 5 Keys for a direct activation of the functions
Alarms	CH ₄ / C ₃ H ₈ concentration threshold Pump stopped
Sound level of the buzzer (30cm)	65 dB (A)
Indicators of the device status	Measurement mode Battery level Pump Communication GPS
Electrical connections	Multiplug for battery charger and for a communication with a computer. Equipped with a security ring.
Gas connections	Quick-connect gas inlet coupling with locking mechanism: suction rod on the right side. Quick-connect gas outlet coupling.
Carrying Straps	Synthetic band, 30mm / 1.18”

Additional Accessories and Performance

Type	Response Time (T ₉₀)
	8 seconds
	90 seconds
	120 seconds
	<p>This sample probe requires adequate time to obtain a stable reading.</p> <p>This probe has not been included in the EN 60079-29-1 performance testing.</p>

APPENDIX C - Information On Disposal For Users Of Waste Electrical & Electronic Equipment

The wheelie bin symbol displayed on electrical equipment supplied by QED signifies that the apparatus must not be disposed of through the normal municipal waste stream but through a registered recycling scheme.

The Waste Electrical and Electronic Equipment Directive (WEEE) make producers responsible in meeting their obligations, with the fundamental aim of reducing the environmental impact of electrical and electronic equipment at the end of its life.



QED is registered with the Environmental Agency as a producer and has joined a recycling scheme provider that manage and report on our electrical waste on our behalf.

Note: When your instrument is at the end of its life, please contact your local distributor, or our sales team at QED on +44(0)333 800 0088 or email sales@qedenv.co.uk, who will advise you on the next step in order to help us meet our obligations.

APPENDIX D – Bluetooth Module Compliance

The Bluetooth module has a QDID registered with the Bluetooth SIG :
 QDID: B014867

United States

The device contains Transmitter Module FCC ID: T9J-RN42. This device complies with Part 15 of the FCC Rules. Operation is subject to the following two conditions: (1) this device may not cause harmful interference, and (2) this device must accept any interference received, including interference that may cause undesired operation.

This equipment has been tested and found to comply with the limits for a Class B digital device, pursuant to part 15 of the FCC Rules. These limits are designed to provide reasonable protection against harmful interference in a residential installation. This equipment generates, uses and can radiate radio frequency energy, and if not installed and used in accordance with the instructions, may cause harmful interference to radio communications. However, there is no guarantee that interference will not occur in a particular installation. If this equipment does cause harmful interference to radio or television reception, which can be determined by turning the equipment off and on, the user is encouraged to try to correct the interference by one or more of the following measures:

- Reorient or relocate the receiving antenna.
- Increase the separation between the equipment and receiver.
- Connect the equipment into an outlet on a circuit different from that to which the receiver is connected.
- Consult the dealer or an experienced radio/TV technician for help.

Canada

Certification	Standards	Article	Laboratory	Report Number	Date
Safety	EN 60950-1:2006+A11:2009+A1:2010+A12:2011	[3.1(a)]	Worldwide Testing Services (Taiwan) Co., Ltd.	W6M21402-13966-L	2014-03-24
Health	EN 62479:2010			W6M21402-13966-62479	2014-03-13
EMC	EN 301 489-1 V1.9.2 (2011-09)	[3.1(b)]		W6M21402-13966-E-16	2014-03-13
	EN 301 489-17 V2.2.1 (2012-09)				
Radio	EN 300 328 V1.8.1 (2012-06)	(3.2)		W6M21402-13966-T-45	2014-03-13
Notified Body Opinion	CE0681	—	Eurofins Product Service GmbH	U9M-1404-3736-C-V01	2014-04-15

The device contains transmitter module IC: 6514A-RN42.

This device complies with Industry Canada license exempt RSS standard(s). Operation is subject to the following two conditions: (1) this device may not cause interference, and (2) this device must accept any interference, including interference that may cause undesired operation of the device.

Le présent appareil est conforme aux CNR d'Industrie Canada applicables aux appareils radio exempts de licence. L'exploitation est autorisée aux deux conditions suivantes: (1) l'appareil ne doit pas produire de brouillage, et (2) l'utilisateur de l'appareil doit accepter tout brouillage radioélectrique subi, même si le brouillage est susceptible d'en compromettre le fonctionnement.

Under Industry Canada regulations, this radio transmitter may only operate using an antenna of a type and maximum (or lesser) gain approved for the transmitter by Industry Canada. To reduce potential radio interference to other users, the antenna type and its gain should be so chosen that the equivalent isotopically radiated power (e.i.r.p.) is not more than that necessary for successful communication.

Conformément à la réglementation d'Industrie Canada, le présent émetteur radio peut fonctionner avec une antenne d'un type et d'un gain maximal (ou inférieur) approuvé pour l'émetteur par Industrie Canada. Dans le but de réduire les risques de brouillage radioélectrique à l'intention des autres utilisateurs, il faut choisir le type d'antenne et son gain de sorte que la puissance isotrope rayonnée équivalente (p.i.r.e.) ne dépasse pas l'intensité nécessaire à l'établissement d'une communication satisfaisante.

Europe

The Bluetooth module has been tested to R&TTE Directive 1999/5/EC Essential Requirements for Health and Safety (Article (3.1(a)), Electromagnetic Compatibility (EMC) (Article 3.1(b)), and Radio (Article 3.2) and are summarized below.



QED Environmental Systems

Cyan Park, Unit 3
Jimmy Hill Way
Coventry
CV2 4QP
United Kingdom

sales@qedenv.co.uk

www.qedenv.com



+44 (0)333 800 0088