

# QED™ LANDTEC

BIOMETHANE 3000



## OPERATING MANUAL



Operating Manual

**TABLE OF CONTENTS**

Manual guidelines.....5

    Safety symbol.....5

    Hyperlinks .....5

    Notes.....5

Safety information .....6

    Safety instructions .....6

    Certification .....7

    Marking.....11

    Range of environmental conditions .....12

    Safety symbols used on the instrument.....13

BIOMETHANE 3000 Overview .....14

    Features .....14

    Benefits .....15

    Options .....15

    Main Applications .....15

    BIOMETHANE 3000 Summary .....16

    Internal Components .....17

    BIOMETHANE 3000 Module Features.....20

Installation .....22

    Pre-Installation Requirements .....22

    External Customer Connections.....24

    Mounting the Enclosures .....26

    Installation Schematic.....28

    Connecting the Gas Lines to the BIOMETHANE 3000 .....29

    Drain .....31

    Connecting the Gas Lines to the Auto-Calibration System.....32

    Protective Cover .....33

    Cable Gland Selection and Cord Anchorage.....34

    Wiring .....36

    Cable Conductor Sizes and Insulation Requirements.....37

# Operating Manual

Modbus Digital Output .....	41
4-20mA Outputs .....	48
Relays .....	50
Profibus Digital Output .....	51
Profinet Digital Output.....	56
Ethernet Digital Output.....	61
Wiring the Ethernet Input.....	66
Heater .....	68
Fitting/Replacing the Disposable Gas Cylinder.....	68
Final Checks .....	69
<b>General Operating Instructions.....</b>	<b>70</b>
Switching the BIOMETHANE 3000 System On .....	70
System Start-Up .....	70
Help Function.....	73
First Time Configuration .....	74
Gas Readings Screen .....	75
Alarms .....	78
Stop Sampling .....	80
Menu.....	80
BIOMETHANE 3000 Sampling Process .....	110
Switching the BIOMETHANE 3000 System Off .....	111
<b>Gas Check and Calibration .....</b>	<b>112</b>
Introduction .....	112
Required Equipment .....	113
Gas Mixtures .....	114
Connecting a Gas Bottle to the BIOMETHANE 3000 for a Manual Calibration .....	118
Gas Check and Calibration .....	120
Status Icons.....	122
Disconnecting a Gas Bottle from the BIOMETHANE 3000 .....	123
<b>Maintenance.....</b>	<b>125</b>
Maintenance Schedule .....	125
BIOMETHANE 3000 Consumable Products .....	127

## Operating Manual

Emptying the Catchpot .....	129
Replacing the Catchpot Filter .....	132
Replacing the Inline PTFE Filter .....	136
Pressure Test.....	139
Setting the Auto-Calibration Pressure Regulator .....	143
Cleaning and Decontamination .....	143
<b>Service.....</b>	<b>144</b>
General .....	144
Service Notifications .....	144
Replacement BIOMETHANE 3000 Module for Service – Hot Swap.....	144
<b>Problem Solving .....</b>	<b>147</b>
Fault Detection .....	147
Non-Critical Faults.....	147
Critical Faults.....	148
System Will Not Power On .....	149
Module Will Not Power On .....	149
Module Lock-Up.....	150
Under and Over Range Codes .....	150
Analog Outputs Not Working.....	150
Modbus Outputs Not Working.....	151
Low Flow / Flow Fail.....	151
Fuses .....	152
User Calibration Explained .....	153
CH4 Reading Low and O2 Reading High.....	155
<b>BIOMETHANE 3000 Warranty Terms and Conditions .....</b>	<b>156</b>
<b>Glossary of Terms .....</b>	<b>158</b>

## Operating Manual

**MANUAL GUIDELINES**

## Safety symbol

Information in this manual that may affect the safety of users and others is in the following format:



Information in this manual that may affect the safety of users and others will be placed in a box identical to this one.

Failure to follow this information may result in physical injury that in some cases could be fatal, cause damage to the equipment or to the environment, or invalidate the certification of the equipment.

## Hyperlinks

Hyperlinks to other sections of this manual, websites or email addresses are in the following format:

[www.qedenv.com](http://www.qedenv.com)

## Notes

Important/useful information and instructions are shown clearly throughout the manual in a note format. For example:

Note: For further information please contact Technical Support at QED at (800) 624-2026 or email [service@qedenv.com](mailto:service@qedenv.com).

## Operating Manual

**SAFETY INFORMATION**

## Safety instructions

The BIOMETHANE 3000 comes with a guard that covers all accessible components with mains power. This guard must only be removed when power to the system is isolated. Failure to isolate the supply could result in an electric shock.

When opening the cabinet great care must be taken by the operator as mains voltages are present. It is the responsibility of the owner of the equipment to ensure that all personnel are adequately trained.

It is the responsibility of the owner of this equipment to complete a risk assessment on its installation, operation, and maintenance prior to it being used.

Anti-static precautions should be observed during installation, maintenance, and general operation of the equipment.



Inhaling toxic gases may be harmful to health and in some cases may be fatal. It is the responsibility of the user to ensure that he/she is adequately trained in the safety aspects of the gases being used and appropriate procedures are followed. In particular, where hazardous gases are being used, the gas exhausted from the system must be piped to an area where it is safe to discharge the gas, or returned to the process.

The equipment should not be altered in any way other than described within this operating manual. Alterations or changes outside of this operating manual could make the equipment unsafe and invalidate the hazardous area certification.

It is vital that the instructions in this operating manual are followed closely. Failure to comply could cause an injury to the operator.

The auto-drain pump will need replacing before 4,000 hours use. At 3,000 hours, a non-critical fault will appear on screen to advise the user that replacement is due. At 4,000 hours, a critical fault will occur and stop the system from operating until replaced.

- Suitably trained personnel should carry out the installation in accordance with the applicable code of practice.
- Repair and maintenance of this equipment should be carried out in accordance with the applicable code of practice and this operating manual.
- Only QED approved components are to be used as replacement parts.
- If the equipment is likely to be exposed to aggressive substances (e.g. acidic liquids, gases that may attack metals or solvents that may affect polymeric materials) then it is the responsibility of the user to take suitable precautions, e.g. regular checks are performed as part of routine inspections or establishing from the material's datasheet that it is chemically resistant.

**Note:** For further information please contact Technical Support at QED at (800) 624-2026 or email [service@qedenv.com](mailto:service@qedenv.com).



## Operating Manual

## Certification



The equipment is designed for use in potentially explosive atmospheres as defined by the classification. The equipment can be configured to measure low levels of several gases, but may not be certified for use in potentially explosive atmospheres of these gases. It is the responsibility of the operator to determine the protection concept and classification of equipment required for a particular application and if these gases create a potentially explosive atmosphere.

The equipment should not be altered in any way other than described within this operating manual. Alterations or changes outside of this operating manual will invalidate the certification and could make the apparatus unsafe.

Only the BIOMETHANE 3000 system is certified for use in a potentially explosive atmosphere. The auto-calibration system must be situated in a safe area.

## ATEX and IECEx

In reference to European ATEX Directive 2014/34/EU and the IECEx International Certification Scheme, the BIOMETHANE 3000 has been certified according to the following designation:



II 3G

Ex nA nC IIA T1 Gc (-20°C ≤ Ta ≤ +50°C)

## CSA Certification

For CSA (Canada) the 3000 series of gas analyzers are certified to Hazardous Area Classification

CLASS 2258 02 – PROCESS CONTROL EQUIPMENT – For Hazardous Locations



Ex nA nC IIA T1 Gc

BIOMETHANE 3000 Fixed Position Gas Analyzer ; With Supply Terminal rated 110-230Vac, 50/60Hz, 0.5-0.24A(without heater), 1.4-0.67A(with heater), 54.25W(Without heater), 154.25W(with heater); 4-20mA channels(total 8 inputs and outputs) rated 24Vdc, 20mA, 480mW; RS485 Signal rated -7V to +12V, Diff' voltage 5V, 83.3mA, 417mW; CANBus rated 0V to 12V, Diff' Voltage 2.3V, 38.33mA, 89mW; Ethernet rated 2.5V Differential, 25mA, 63mW; Relay contact(8 relays) rated 24Vdc, 6A, 144W; -20°C ≤ Tamb ≤ +50°C.

## Operating Manual

**Notes:**

1. The above model is permanently connected, Equipment Class I, Pollution Degree 3, Overvoltage Category II.
2. Mode of operation: Continuous
3. Environmental Conditions: -20°C to 50°C (-4°F to 122°F), 3000 m (9842 ft) max, 95% non-condensing

Conditions of Acceptability applicable to the end user

- 1) All cable entry holes shall be fitted with either a certified cable gland or a certified stopping plug with minimum IP65 that is suitable for the application.
- 2) The equipment may only be used in areas with a low risk of mechanical impact.
- 3) Warning – in locations where high external humidity and internal temperature variations (e.g. frequent on-off cycles) may cause condensation inside the equipment, the interior should be periodically inspected.
- 4) The terminal blocks shall only be fitted with wires that have cross sectional area falling within the terminal blocks certificates limitations. Refer to operating manual.
- 5) Equipment is mounted such that it is protected from exposure to direct sunlight, precipitation, and full wind pressure

CAN/CSA-C22.2 No. 0-10 (R 2015) 2011	General requirements — Canadian Electrical Code, Part II
CAN/CSA-C22.2 No. 60079-0:2015	Explosive atmospheres – Part 0: Equipment – General requirements
CAN/CSA-C22.2 No. 60079-15:2016	Electrical apparatus for explosive gas atmospheres – Part 15
CSA-C22.2 No. 61010-1-12, UPD1:2015, UPD2:2016	Safety Requirements for Electrical Equipment for Measurement, Control, and Laboratory Use, Part 1: General Requirements
CSA C22.2 No. 94.2-15	Enclosures for electrical equipment, environmental considerations



## Operating Manual

For CSA (USA) the 3000 series of gas analyzers are certified to Hazardous Area Classification

Class 2258 82 – PROCESS CONTROL EQUIPMENT – For Hazardous Locations – Certified to US standards.



**Class I, Zone 2, AEx nA nC IIA T1 Gc**

BIOMETHANE 3000 Fixed Position Gas Analyzer ; With Supply Terminal rated 110-230Vac, 50/60Hz, 0.5-0.24A(without heater), 1.4-0.67A(with heater), 54.25W(Without heater), 154.25W(with heater); 4-20mA channels(total 8 inputs and outputs) rated 24Vdc, 20mA, 480mW; RS485 Signal rated -7V to +12V, Diff' voltage 5V, 83.3mA, 417mW; CANBus rated 0V to 12V, Diff' Voltage 2.3V, 38.33mA, 89mW; Ethernet rated 2.5V Differential, 25mA, 63mW; Relay contact(8 relays) rated 24Vdc, 6A, 144W; -20°C ≤ Tamb ≤ +50°C.

**Notes:**

1. The above model is permanently connected, Equipment Class I, Pollution Degree 3, Overvoltage Category II.
2. Mode of operation: Continuous
3. Environmental Conditions: -20°C to 50°C (-4°F to 122°F), 3000 m (9842 ft) max, 95% non-condensing

Conditions of Acceptability applicable to the end user

- 6) All cable entry holes shall be fitted with either a certified cable gland or a certified stopping plug with minimum IP65 that is suitable for the application.
- 7) The equipment may only be used in areas with a low risk of mechanical impact.
- 8) Warning – in locations where high external humidity and internal temperature variations (e.g. frequent on-off cycles) may cause condensation inside the equipment, the interior should be periodically inspected.
- 9) The terminal blocks shall only be fitted with wires that have cross sectional area falling within the terminal blocks certificates limitations. Refer to operating manual.
- 10) Equipment is mounted such that it is protected from exposure to direct sunlight, precipitation, and full wind pressure

ANSI/UL 60079-0-2013	Explosive atmospheres – Part 0: Equipment – General requirements
ANSI/UL 60079-15-2013	Explosive Atmospheres – Part 15: Type of protection “n”
UL Std. No. 61010-1, 3rd Edition (2012)	Safety Requirements for Electrical Equipment for Measurement, Control, and Laboratory Use - Part 1: General Requirements
UL 50E, 3rd Ed.	Enclosures for electrical equipment, environmental considerations

## Operating Manual

### Instructions Specific to Hazardous Area Installations

- 1) The equipment may be used in zones 2 with flammable gases and vapors with apparatus groups IIA and with temperature classes T1.
- 2) The equipment is only certified for use in ambient temperatures in the range -4°F to +122°F (-20°C to +50°C) and should not be used outside this range.
- 3) Installation shall be carried out in accordance with the applicable code of practice by suitably trained personnel.
- 4) There is no special checking or maintenance conditions other than a periodic check.
- 5) With regard to explosion safety, it is not necessary to check for correct operation.
- 6) The equipment contains no user-replaceable parts and is not intended to be repaired by the user. Repair of the equipment is to be carried out by the manufacturer, or their approved agents, in accordance with the applicable code of practice.

**Note:** Please contact our technical support team at QED at (800) 624-2026 or email [service@qedenv.com](mailto:service@qedenv.com) to receive training on repairing the equipment and becoming an approved repair agent.

- 7) Repair of this equipment shall be carried out in accordance with the applicable code of practice.
- 8) If the equipment is likely to come into contact with aggressive substances, e.g. acidic liquids or gases that may attack metals or solvents that may affect polymeric materials, then it is the responsibility of the user to take suitable precautions that prevent it from being adversely affected thus ensuring that the type of protection is not compromised.
- 9) The certificate number has an 'X' suffix, which indicates that special conditions of installation and use apply. Those installing or inspecting this equipment must have access to the contents of the certificate or these instructions. The conditions listed in the certificate are reproduced below:
  - All cable entry holes shall be fitted with either a certified cable gland or a certified stopping plug with minimum IP65 that is suitable for the application.
  - The equipment may only be used in areas with a low risk of mechanical impact.
  - Warning – in locations where high external humidity and internal temperature variations (e.g. frequent on-off cycles) may cause condensation inside the equipment, the interior should be periodically inspected.
  - The terminal blocks shall only be fitted with wires that have cross sectional area falling within the terminal blocks certificates limitations and any unused terminals shall be tightened. Refer to operating manual.
  - Equipment has only been assessed for electrical safety. No non-electrical assessment has been conducted and the manufacturer declares compliance for this under his own responsibility.
- 10) Cell replacement must only be carried out in the safe area or when a hazardous atmosphere is not present.

## Operating Manual



Only the BIOMETHANE 3000 system is certified for use in a potentially explosive atmosphere. The auto-calibration system must be situated in a safe area.

Note: Additional instructions shall be supplied alongside any replacement cell related to the specific installation requirements.

Note: Regarding the use of covers, jumpers, cross connectors, end brackets, or any other accessories of the terminals, the instructions of the manufacturer must be followed.

### Entity Parameters







The following ratings must not be exceeded on the listed circuits below:

Circuit	Ur (rated voltage)	Ir (rated current)	Pr (rated power)
Relay coil	24Vdc	6A	144W
4-20mA	24Vdc	20mA	480mW
RS485 Modbus	-7 to +12V	83.3mA	417mW
Ethernet	2.5Vdc	25mA	63mW

### Marking

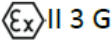
In reference to European ATEX Directive 2014/34/EU, the IECEx International Certification Scheme and CSA North American Certification, Nameplate 1 can be found on the main enclosure of the system.

Operating Manual

 <b>BIOMETHANE 3000</b> PART OF THE BIOGAS 3000 PRODUCT FAMILY  QED Environmental Systems Manufactured at US Headquarters: 2355 Bishop Cir W, Dexter, MI 48130, USA Tel: +1 734-995-2547			
 Ex nA nC IIA T1 Gc (-20°C ≤ Ta ≤ +50°C) Sira 16ATEX4203X IECEx SIR 16.0069X CLASS 1, ZONE 2, AEx nA nC IIA T1 Gc  CSA 19.70205126X Ex nA nC IIA T1 Gc ENCLOSURE TYPE 4X & IP65	 	WARNING: DO NOT OPEN WHEN WITHIN EXPLOSIVE ATMOSPHERE. AVERTISSEMENT: NE PAS OUVRIR EN ZONE EXPLOSIVE WARNING: DO NOT REMOVE OR REPLACE FUSES WHEN ENERGIZED AVERTISSEMENT: NE PAS ENLEVER OU REMPLACER LES FUSIBLES SOUS TENSION WARNING: ISOLATE SUPPLY BEFORE REMOVING INTERNAL COVER AVERTISSEMENT: METTRE HORS TENSION AVANT L'OUVERTURE DU BOITIER	
SERIAL NO.		YEAR OF MANUFACTURE.	
<b>EXTERNAL CONNECTION RATINGS</b>			
<b>CIRCUIT</b>	<b>Ur</b>	<b>Ir</b>	<b>Pr</b>
Mains Supply (No Heater)	110V AC ~ 60Hz	0.5A	54.25W
	230V AC ~ 50Hz	0.24A	
Mains Supply (With Heater)	110V AC ~ 60Hz	1.4A	154.25W
	230V AC ~ 50Hz	0.67A	
RS485 Modbus	-7V to +12Vdc	83.3mA	417mW
CAN Bus	0V to +12Vdc	38.33mA	89mW
Ethernet	2.5Vdc	25mA	63mW
Relays	24Vdc	6A	144W
4-20mA	24Vdc	20mA	480mW

Nameplate 1 - BIOMETHANE 3000 markings

Note: The BIOMETHANE 3000 is part of the BIOGAS 3000 product family.

Range of environmental conditions





- The system is only for use in ambient temperatures in the range of -4°F to +122°F (-20°C to +50°C) with the use of the approved heater.
- The BIOMETHANE 3000 is designed for use outdoors and has an IP65 rating.
- The mains voltages (110-230V) can fluctuate up to ±10% of the nominal voltage.
- Transient Overvoltages up to the levels of 2500V (Overvoltage Category II)
- Temporary overvoltages occurring on the mains supply must not exceed +1200V short term and +250V long term
- Pollution degree 3 rating.
- The system is only for use in the humidity range of 0-95% RH non-condensing.
- The system is only for use in ambient pressures in the range 20.67 to 35.44in.Hg (700 to 1200mbar). 20.67in.Hg (700mbar) equates to a maximum altitude of nominally 9,842 ft (3,000 metres) above sea level.

## Operating Manual

If the equipment is used in a manner not specified by the manufacturer, the protection provided by the equipment may be impaired.

### Safety symbols used on the instrument

The following safety symbols are used on the BIOMETHANE 3000:

	Protective conductor terminal
	Caution, risk of electric shock
	Function earth (ground) terminal
	Caution
	Caution, risk of hot surface



Where the symbol  or  is used in the BIOMETHANE 3000, the operating manual must be consulted.

## Operating Manual

## BIOMETHANE 3000 OVERVIEW

## Features



The ATEX, IECEx and CSA certified BIOMETHANE 3000 builds on field proven, robust gas analysis technology providing a fixed online gas analysis system specifically designed and optimized for gas-to-grid injection. The product was created in conjunction with leading plant providers to deliver greater accuracy and confidence in gas quality for the biomethane gas analysis process.

The BIOMETHANE 3000 is regarded by QED as a market-leading approach to monitoring high levels of methane and low levels of oxygen to a high accuracy, and incorporates a 'hotswap' gas monitoring module – which means that customers see 'zero' downtime during service and maintenance, and a new auto-calibration function. The solution has been developed for customers worldwide and features multi-lingual menus, product literature and customer support.

- CH<sub>4</sub>, CO<sub>2</sub> & O<sub>2</sub> – standard measurements
- H<sub>2</sub>S, H<sub>2</sub> and CO – optional measurements (choice of one as an additional gas measurement)
- Modular design enabling hot-swap for serviceability and onsite maintenance
- Auto-calibration function to maintain accuracy and ensure data reliability in extreme temperatures
- ATEX, IECEx, and CSA certified for use in potentially explosive gas atmospheres – Zone 2
- Continuous monitoring
- Internet connectivity allowing remote access to data and settings, process control, calibration, firmware updating and remote technical support
- Gas return to process as standard
- IP65 rated for weatherproofing
- Built-in liquid level monitoring with a dedicated alarm to inform the user contents of the catchpot require emptying or an optional automated moisture removal drain
- Gas alarms and fault notifications



## Operating Manual

- 6 x 4-20mA outputs
- Modbus RTU communication
- Optional Profibus and Profinet communication
- Clear, visual and informative color display
- Heater allows system to operate down to -4°F (-20°C)
- Multi-lingual product with literature and technical support now available in German, Spanish, French, Italian, Polish, Chinese, and English.
- Extended Warranty and Service pack options through approved global service centers

### Benefits

- Customizable to site requirements
- Zero operational downtime for servicing
- Product reliability and longevity
- Check gas quality before gas chromatograph
- Operational within hazardous areas
- Ease of operation, integration and installation
- Minimal through-life costs
- Local support for peace of mind

### Options

- H<sub>2</sub>S ranges from 0-50ppm to 0-40,000ppm
- CO 0-1,000ppm
- H<sub>2</sub> 0-1,000ppm
- Profibus replaces Modbus
- Profinet replaces Modbus
- 110V or 230V heater
- Auto-drain to empty contents of catchpot without user interaction

### Main Applications

- Biogas upgrading
- Gas to grid

# Operating Manual

BIOMETHANE 3000 Summary

- The BIOMETHANE 3000 measures CH<sub>4</sub>, CO<sub>2</sub>, and O<sub>2</sub> as standard with an option of one additional gas (external to module only) from one sample point.
- It measures CH<sub>4</sub>, CO<sub>2</sub>, and O<sub>2</sub> continuously that is exhausted back to the process.
- The system has a user-scheduled auto-calibration that can occur at set intervals with a minimum frequency of once every 24-hours.
- The external sensor has user selectable sample intervals that are exhausted back to the process. The external sensor cannot be subjected to the gas stream continuously.
- After each defined cycle, the external sensor is subjected to a user definable air purge that is exhausted to the atmosphere.
- The 4-20mA and Modbus outputs are updated continuously, with the external sensor data being refreshed at the end of each sample
- The following images are two simple block diagrams of the system with one including the optional external gas sensor:

No external sensor

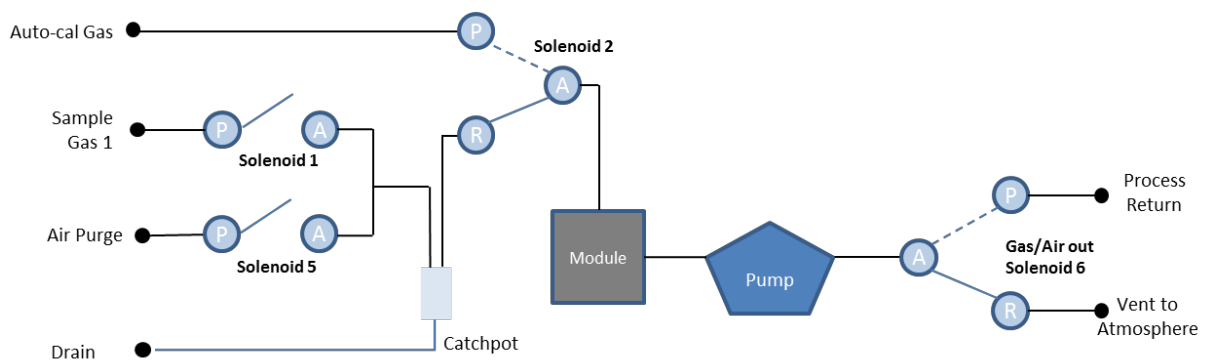

With an external sensor

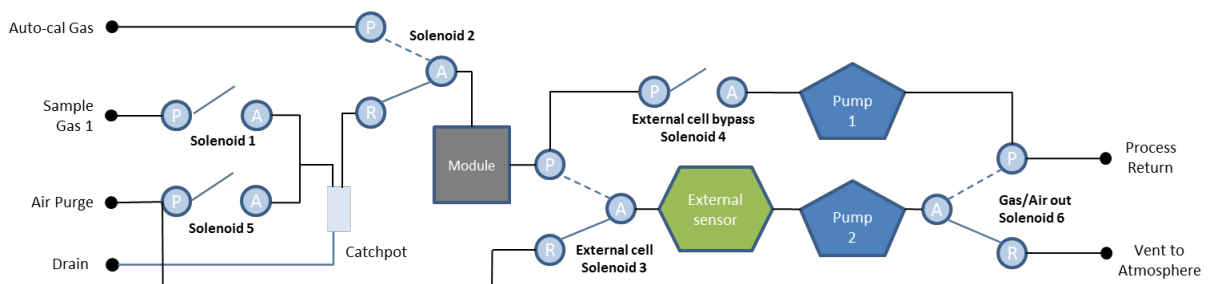

## Operating Manual

Internal Components

BIOMETHANE 3000 System

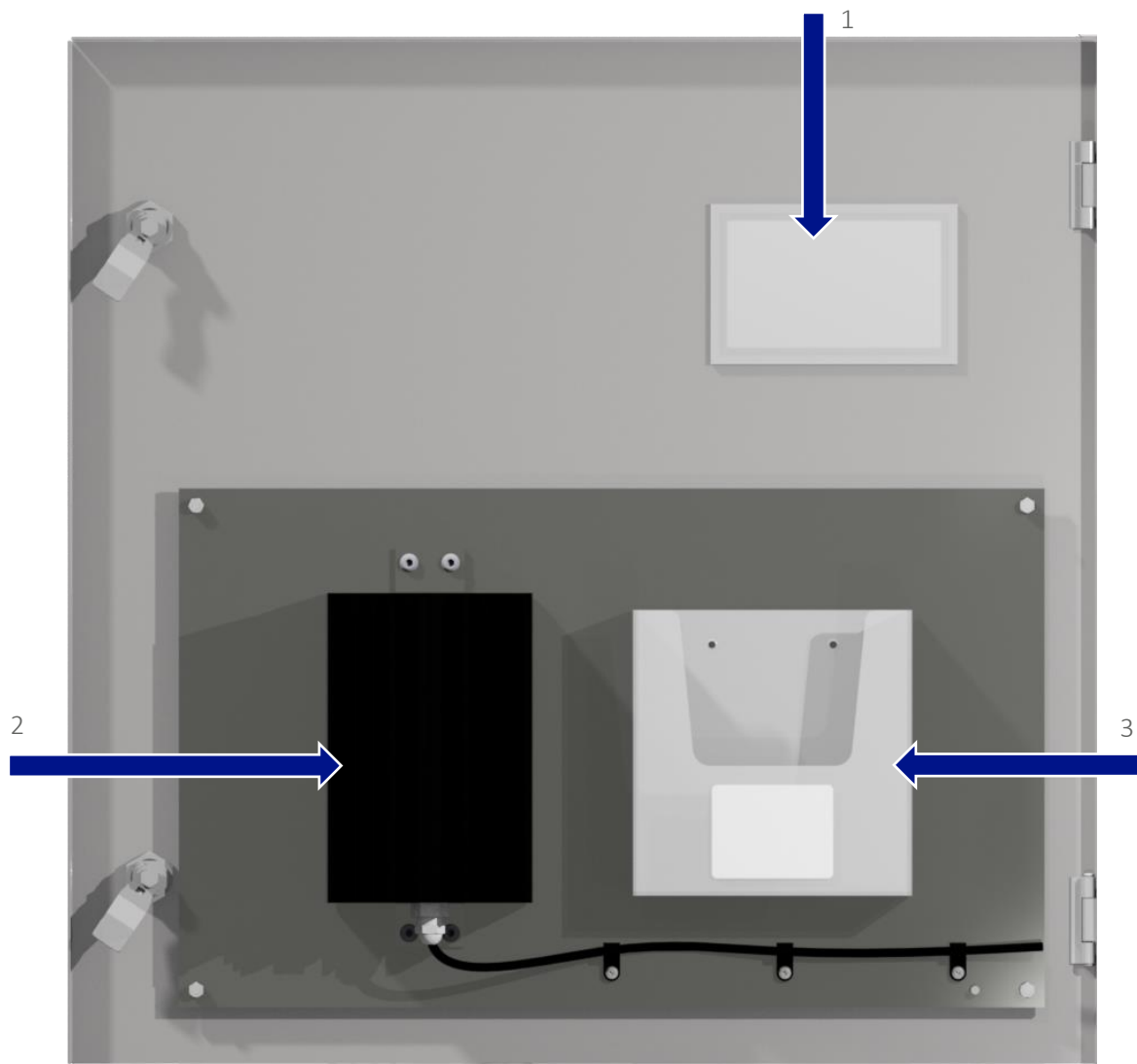

Figure 1 - BIOMETHANE 3000 door internals

- 1) Viewing window
- 2) Heater (110V or 230V)
- 3) Plastic wallet containing operating manual, wiring diagram, and calibration certificate

Operating Manual

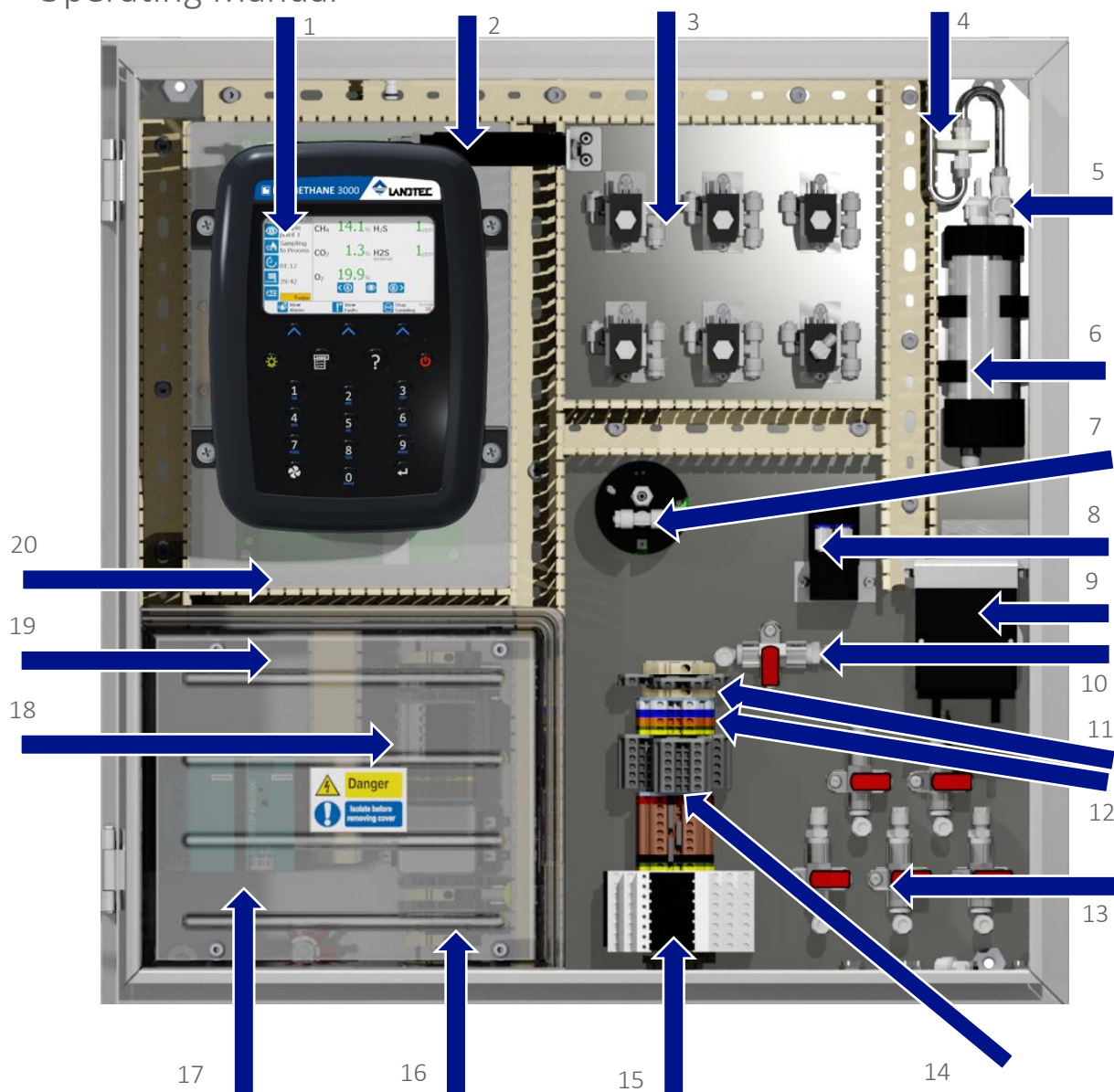

Figure 2 - BIOMETHANE 3000 internal components

- |  |                                   |
|--|-----------------------------------|
| 1) BIOMETHANE 3000 module                | 11) Pressure transducer terminals |
| 2) Heater thermostat                     | 12) Modbus terminals              |
| 3) Solenoid valves                       | 13) Gas in/out valves             |
| 4) Inline PTFE filter                    | 14) 4-20mA terminals              |
| 5) Female QRC for calibration            | 15) Relays                        |
| 6) Catchpot with liquid level switch     | 16) Mains supply terminals        |
| 7) External sensor                       | 17) Power supplies                |
| 8) Pumps                                 | 18) Fuses                         |
| 9) Auto-drain pump (or drain ball valve) | 19) Protective cover              |
| 10) Calibration valve                    | 20) Interface PCB                 |

Operating Manual

Auto-Calibration System

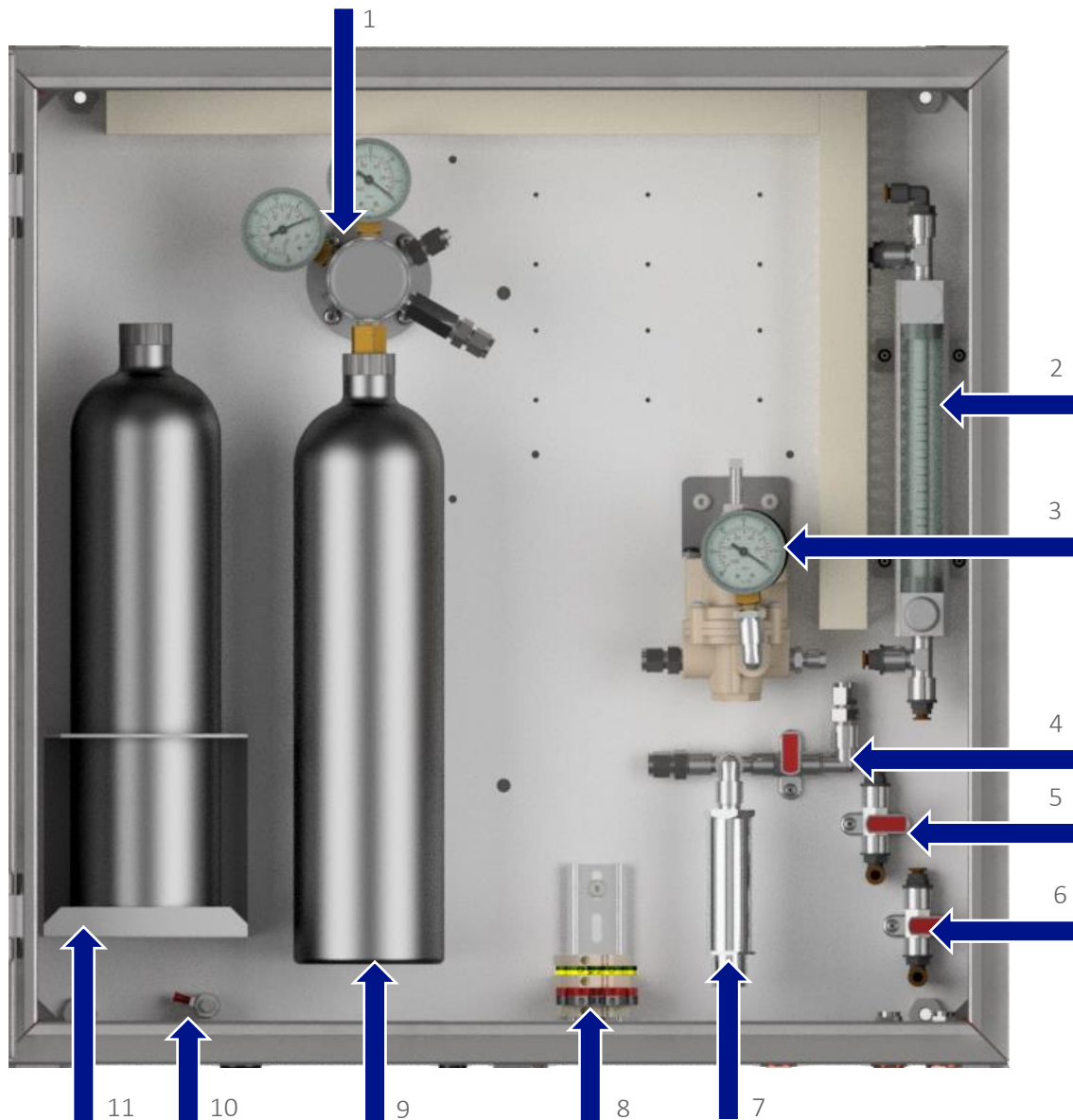

Figure 3 – Auto-Calibration internal components

- |  |   |
|--|---|
| 1) Disposable cylinder pressure regulator (primary regulator)* | 6) Bypass valve                             |
| 2) Flow meter  | 7) Pressure transducer                      |
| 3) Secondary regulator   | 8) Pressure transducer and ground terminals |
| 4) Inlet valve   | 9) Disposable gas cylinder                  |
| 5) Outlet valve  | 10) Protective conductor terminal           |
|  | 11) Spare disposable gas cylinder holder    |

Note: Items marked with \* are only present on auto-calibration systems for disposable gas cylinders. Auto-calibration internal components may vary slightly for the refillable cylinder option.

Operating Manual

BIOMETHANE 3000 Module Features

Physical Characteristics of the Module

Front View:



Reference:

- 1) Display
- 2) Soft keys
- 3) Help key
- 4) On/off key
- 5) Keypad
- 6) Return key (↵)
- 7) Pump key
- 8) Backlight key
- 9) Menu key

Rear View:



- 10) Module mounting brackets
- 11) Rear label

Top View:

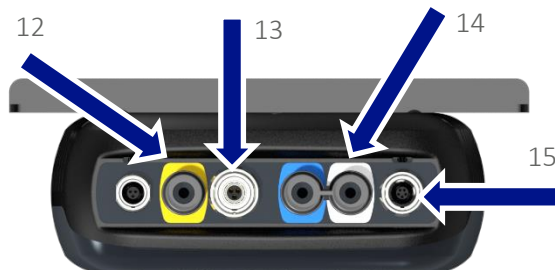

- 12) Gas outlet
- 13) Power supply connector
- 14) Gas inlet
- 15) Communications connector

Figure 4 - BIOMETHANE 3000 Module Features



## Operating Manual

## Definitions

## Front View

## Reference

16) Display

## Definition

Shows information to the user.

17) Soft keys

The function of the three soft keys on the keypad is determined by the screen the operator is in.

18) Help key

Where '?' is shown on the display, the operator can press the help key for on-screen assistance.

19) On/off key

Press the on/off key for two seconds to switch the module on and off.

20) Keypad

Allows numeric entry from 0-9 and letters A-Z.

Keys '2', '4', '6' and '8' allow the operator to navigate 'up', 'right', 'left' and 'down' respectively in certain menu items.

Key '0' is also used as the space key when entering text.

21) Return key (↵)

The ↵ accepts/confirms choices made by the operator for various functions and operations.

22) Pump key

Not used in normal operation but is used to aid diagnostics and assist with maintenance. It does not control the pump.

23) Backlight key

Enables the operator to turn the backlight off and on.

24) Menu key

Press the 'menu' key to navigate to the 'menu'.

## Rear View

25) Module mounting brackets

Securely holds the module to the backplate.

26) Rear label

The serial number is the unique identification number for the BIOMETHANE 3000 module. The part number is the unique record for the internal configuration of the BIOMETHANE 3000 module at time of manufacture or last service.

## Top View

27) Gas outlet

The gas sample exits the BIOMETHANE 3000 module here.

28) Power supply connector

Power supplied from the Interface PCB connects here.

29) Gas inlet

The gas sample enters the BIOMETHANE 3000 module here.

30) Communications connector

Connection point for the USB lead from the Interface PCB.

## Operating Manual

### INSTALLATION

#### Pre-Installation Requirements

##### General

It is QED's recommendation that the installation of the BIOMETHANE 3000 is carried out in accordance with this operating manual and the latest edition of IEC 60079-14. Any electrical work should be carried out by a competent electrician and any relevant codes of practice should be followed.

In order to effectively install the BIOMETHANE 3000 system, it is important that the site is ready and in a fit state. In particular, the following points should be noted:



Power should NOT be applied before all piping and wiring has been completed and tested.

Only a qualified person should make electrical connections to the system.

- This operating manual has been read and fully understood
- A risk assessment has been performed that includes installation, operation, and maintenance of the system and the removal, where practicably possible, of any identified hazards
- Applicable codes of practice identified
- The complete BIOMETHANE 3000 system has been received on site, unpacked, packaging contents checked, and checked for obvious damage
- A suitable location is determined for the installation of the instrumentation, paying particular attention to the location of non-disposable gas cylinders

Note: Refer to section [Mounting the Enclosure](#) for items that need to be considered.

- A suitable mains supply as detailed in this manual is installed
- All required gas lines are installed

Note: Inlet pressure to the BIOMETHANE 3000 system must not exceed 140in.H<sub>2</sub>O (350mb). Where this is exceeded, additional pressure regulation is required.

Note: The gas flow to the BIOMETHANE 3000 system must not exceed 500cc/min (500ml/min). Where this is exceeded, additional flow control is required.

- Output data cable has been installed (if required) to the BIOMETHANE 3000 location.

Note: Failure to comply with any of the above may result in additional time on site and additional costs.

Note: Refer to [Installation Schematic](#) for a simple schematic of the overall system configuration once installed.

## Operating Manual

### Packaging Contents

Check the product box for the following items:

- BIOMETHANE 3000 system
- BIOMETHANE 3000 auto-calibration system
- Key for enclosure locks
- Enclosure wall mounting brackets and fasteners
- Operating manual – found in plastic wallet on the inside of the enclosure door
- Customer wiring diagram – found in plastic wallet on the inside of the enclosure door
- Calibration certificate – found in plastic wallet on the inside of the enclosure door
- Compression fittings – found on the bulkheads on the enclosure base (see annotations 4, 5, and 7-11 on [Figure 5 - BIOMETHANE 3000 customer connections](#) and annotation 4-6 on [Figure 6 – Auto-calibration customer connections](#)).
- Particulate filter for air purge line (QED part number 2008277/S, see section [BIOMETHANE 3000 Consumable Products](#)).

### Storage of the System and Module

The BIOMETHANE 3000 system and module should not be exposed to extremes of temperature. It is the user's responsibility to ensure the system and module are kept within their ambient operating temperature range.

### Ventilation Requirements



If the system is being installed indoors, it is QED's recommendation that a suitable gas leak detector is placed nearby to the system to inform operators of a leak before entering the room. This is not supplied by QED.

### BIOMETHANE 3000 System

There is an enclosure breather fitted to the BIOMETHANE 3000 situated at the base of the enclosure (see annotation 13 on [Figure 5 - BIOMETHANE 3000 customer connections](#)). It is the user's responsibility to ensure that there is a free circulation of air around the cabinet.

### Auto-Calibration System

There are two enclosure breathers fitted to the auto-calibration system, situated at the base of the enclosure (see annotation 1 on [Figure 6 – Auto-calibration customer connections](#)) and the right hand side of the enclosure. It is the user's responsibility to ensure that there is a free circulation of air around the cabinet.

Operating Manual



As there is high pressure gas connected to or within the auto-calibration enclosure, if there is a gas leak inside, a significant volume of gas could be leaked into the enclosure. The vents will disperse the majority of this gas but it is possible that residual gas could still be trapped within the enclosure. Therefore, when opening the enclosure door, ensure you do this at arms length and step away from the enclosure for 30-seconds before accessing the internals. Failure to comply with this procedure may be harmful to health and in some cases may be fatal.

External Customer Connections

BIOMETHANE 3000 System

The installation will require the operator to connect a mains cable, output cable, relay cable, pressure transducer cable, drain, and gas pipes to the equipment. [Figure 5 - BIOMETHANE 3000 customer connections](#) identifies the available connection points on the BIOMETHANE 3000:

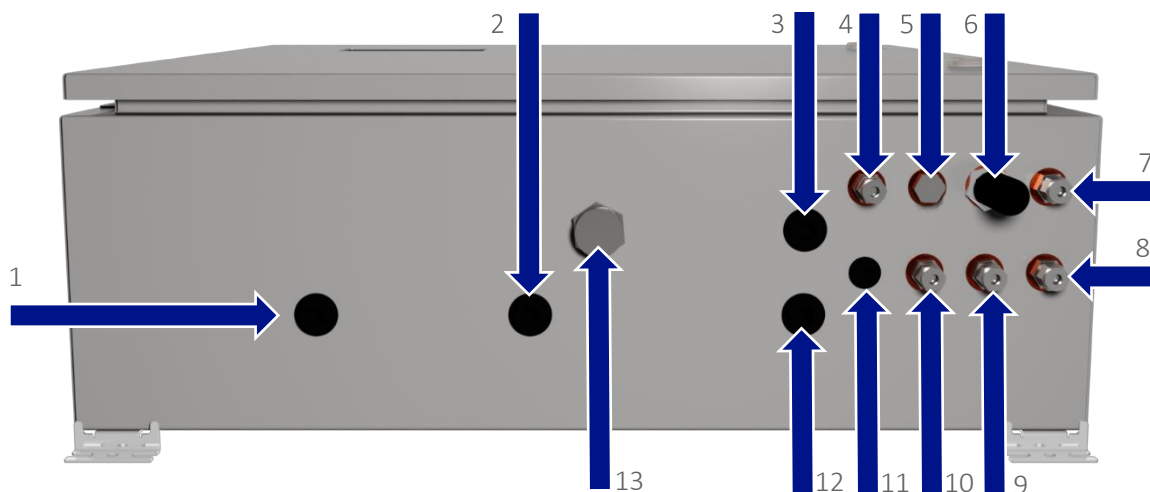

Figure 5 - BIOMETHANE 3000 customer connections

- |  |  |
|--|--|
| 1) Customer cable entry – mains supply | 8) Drain                                       |
| 2) Customer cable entry – ethernet     | 9) Vent to Atmosphere                          |
| 3) Customer cable entry – data outputs | 10) Auto-calibration gas in (from auto-cal)    |
| 4) Sample Gas 1                        | 11) Customer cable entry – pressure transducer |
| 5) Not used                            | 12) Customer cable entry – relays              |
| 6) Air In                              | 13) Breather Drain                             |
| 7) Process Return                      |  |

Operating Manual

Note: There are five stopping plugs fitted to the enclosure for the customer’s cable entry. An M20 stopping plug must be removed from annotations 1-3 and 12, and an M12 stopping plug is to be removed from annotation 11 where a cable gland is to be placed. Where a cable entry point is not being used, the stopping plug must remain in place in order to maintain the IP rating of the enclosure.



The mains and output cables must enter the cabinet via a cable gland (see [Cable Gland Selection and Cord Anchorage](#)) and the mains supply should be isolated (see [Wiring](#))

Auto-Calibration System

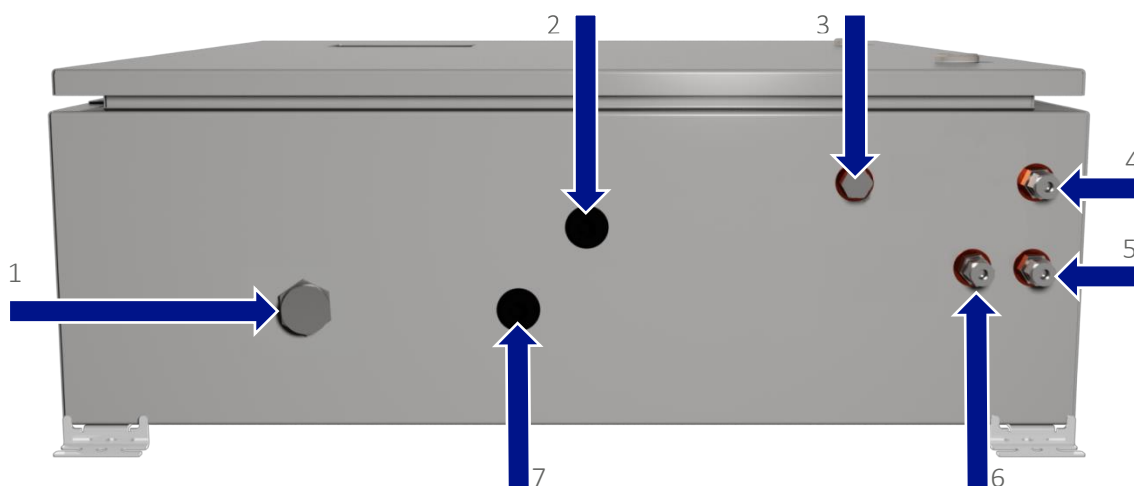

Figure 6 – Auto-calibration customer connections

- |   |   |
|---|---|
| 1) Breather drain                             | 5) High pressure vent                       |
| 2) Customer cable entry – pressure transducer | 6) Calibration gas out (to BIOMETHANE 3000) |
| 3) Refillable gas cylinder in                 | 7) Customer cable entry – ground            |
| 4) Low pressure vent                          |   |

Note: There are two stopping plugs fitted to the enclosure for the customer’s cable entry. An M20 stopping plug must be removed from annotations 2 and 7 where a cable gland is to be placed. Where a cable entry point is not being used, the stopping plug must remain in place in order to maintain the IP rating of the enclosure.



The mains and output cables must enter the cabinet via a cable gland (see [Cable Gland Selection and Cord Anchorage](#)) and the mains supply should be isolated (see [Wiring](#)).

## Operating Manual

### Mounting the Enclosures

The system is comprised of two enclosures that are weatherproof and have a rating of IP65.

When considering the location of the equipment, the following must be considered:

- Although the enclosure is IP65, it shall be installed in a location so that it is protected against exposure to direct sunlight, precipitation and full wind pressure. For example, maintenance of the system will be made easier and safer if it is not exposed to driving rain
- Allow easy access for routine maintenance to be undertaken
- Allow easy viewing of the module display through the viewing window
- In the unlikely event that a gas leak was to occur, ensure that the auto-calibration is installed in an area with good ventilation.
- Any future changes in the area, for example plantation growth causing damage to pipework
- Ensure there is no risk of damage from vehicles or animals in the area
- Avoid positioning the enclosure in direct sunlight as this may increase the internal temperature of the cabinet to outside of the operating temperature range of the equipment.

**Note: If it is difficult to position the BIOMETHANE 3000 system out of direct sunlight, measures shall be taken to protect the system, such as a basic cover to provide shade.**

The enclosure is to be mounted to a solid brick wall or framework (preferably stainless steel) capable of holding the weight of the system. The weight of the enclosure and contents will depend on the options that are fitted, but the maximum weight is 32kg per enclosure. It is therefore recommended that the installation be undertaken by a minimum of two people.

Depending on the revision of the enclosure, the wall mounting brackets will either be pre-fitted at manufacture, or supplied for customer fitting.

### Pre-fitted wall mounting brackets



Although the wall mounting brackets are fitted and tested at manufacture, during transit it is possible that they could have worked loose. Prior to installation, ensure the wall mounting brackets are securely fitted to the BIOMETHANE 3000 system.

Four mounting brackets are supplied and fitted to each corner of the enclosure. Suitable nut and bolt or rawl bolt arrangements will have to be defined by the operator for fixing to the wall or framework (it is recommended that these are stainless steel). The enclosure should be mounted as square and level as possible.

### Fitting the wall mounting brackets to the enclosure

Attach the supplied mounting brackets to each of the four corners of the enclosure using the provided fasteners, as per [Figure 7](#).



Operating Manual



Apply a tightening torque of 8Nm.

Failure to meet the installation requirements could make the equipment unsafe resulting in a hazard and invalidate the hazardous area certification.

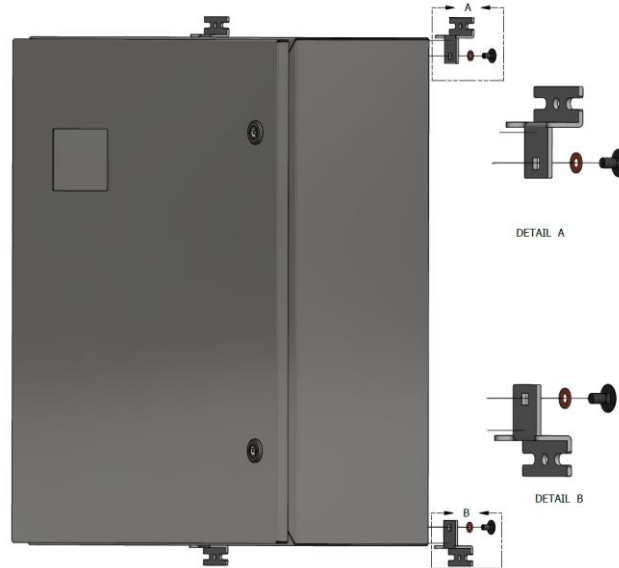

Figure 7 - Fitting the wall mounting brackets to the enclosure

Suitable nut and bolt or rawl bolt arrangements will have to be defined by the operator for fixing to the wall or framework (it is recommended that these are stainless steel). The enclosure should be mounted as square and level as possible.

Dimensions of the enclosures are provided in [Figure 8 - BIOMETHANE 3000 enclosure dimensions](#) and are typical for both.

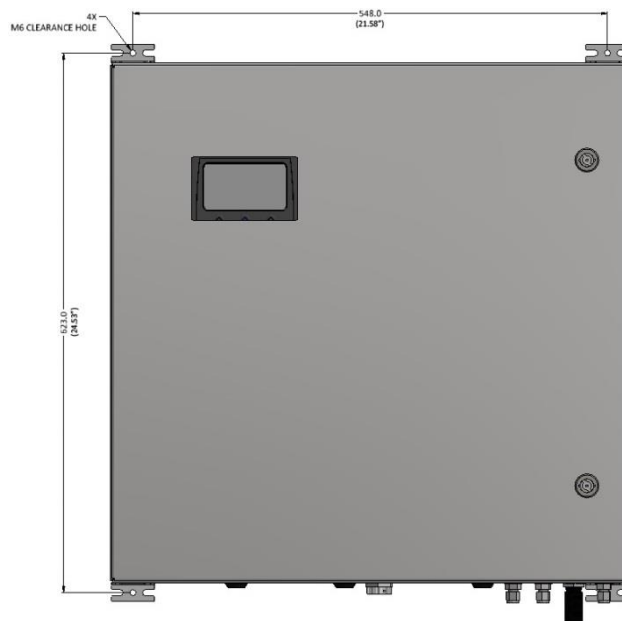
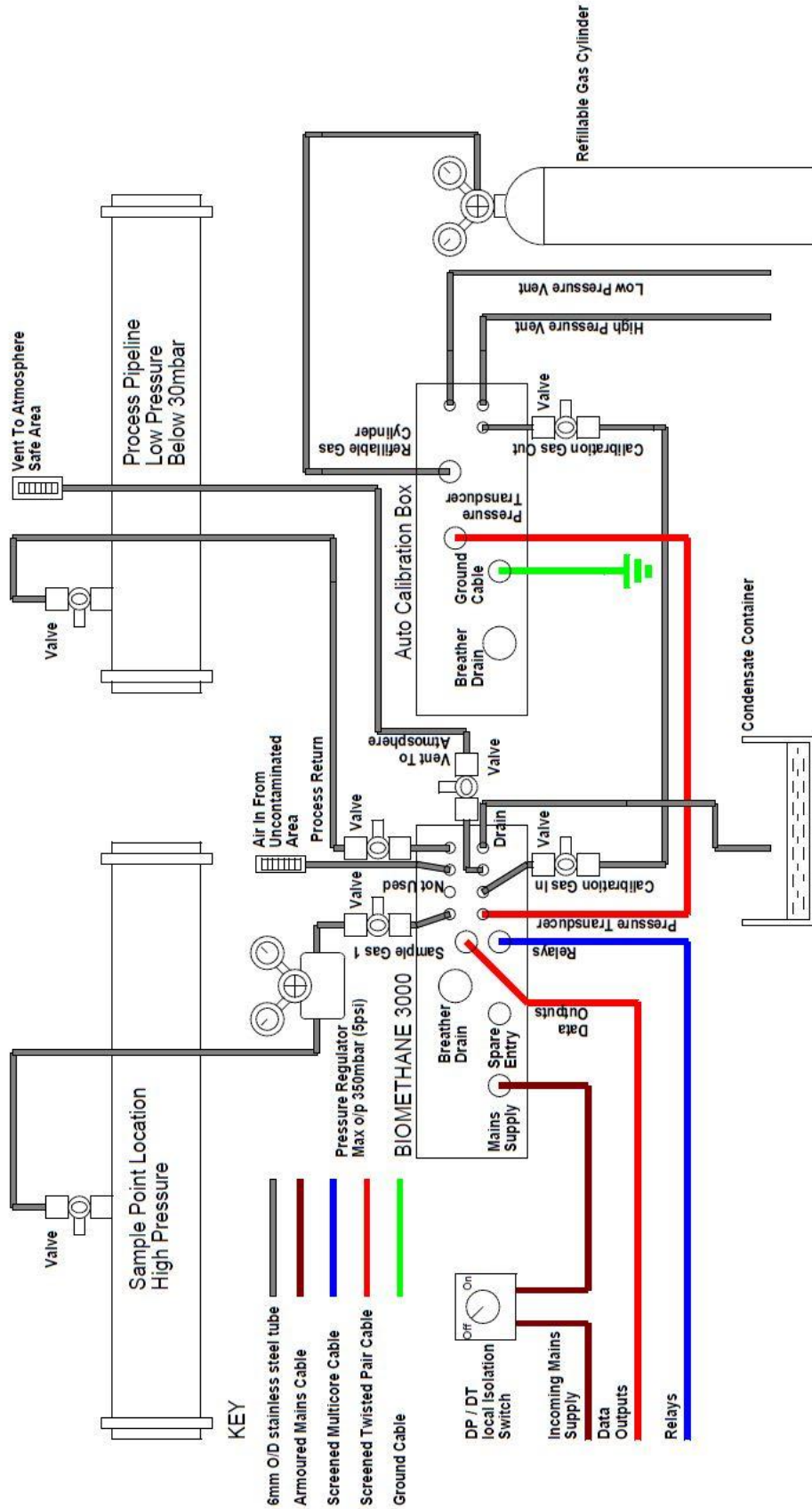

Figure 8 - BIOMETHANE 3000 enclosure dimensions

Operating Manual

Installation Schematic

Below is a simple schematic for how the overall installation should look. To maintain the certification of the instrument, the detailed installation instructions throughout this manual must be read.



## Operating Manual

### Connecting the Gas Lines to the BIOMETHANE 3000

Note: The gas connections on the system are 1/4" stainless steel bulkhead connectors with a compression fitting suitable for 1/4" outer diameter tubing. It is recommended that stainless steel tubing be used where possible.

Note: After installation, ensure all tube connections are tight and free from leaks. See section [Pressure Test](#).

#### Gas Sample Line

Care should be taken in routing the sample line, especially in cold environments. The sample line may need insulating or even trace heating to prevent freezing of water within the pipe. This is not part of the BIOMETHANE 3000 system and is the responsibility of the operator.

- The sample should be taken from a suitable location at the required monitoring point. It is recommended that a valve be incorporated in the assembly so that the gas can be shut off if the sample line is removed.



Figure 9 - Ball valve assembly

- The line should connect to the upper surface of a horizontal pipe or on a vertical standing pipe. This will prevent excessive amounts of water entering the sample line.
- An additional ball valve should be incorporated in to the sample line close to the BIOMETHANE 3000 system. This ball valve will be used to isolate the gas supply to the system as part of pressure testing the system during routine maintenance.
- The sample tube should be connected to the bulkhead connector labelled 'SAMPLE GAS 1' – see annotation 4 on [Figure 5 - BIOMETHANE 3000 customer connections](#).

Note: The maximum distance the BIOMETHANE 3000 can be from the sample point is 164 ft (50 meters).

## Operating Manual

### Process Return

This is the line where measured gas from the system is exhausted. It can be returned to the process or vented to atmosphere.

**Note:** The BIOMETHANE 3000 has been designed to operate using the pressure within the sample gas line, as this is at a positive pressure. Therefore, if returning the measured gas to the process, it must be returned to a point that is at a lower pressure than that seen on the inlet of the BIOMETHANE 3000, ideally less than 12in.H<sub>2</sub>O (30mbar) (for example, outlet of the digester).

Care should be taken in routing the process return line, especially in cold environments. The process return line may need insulating or even trace heating to prevent freezing of water within the pipe. This is not part of the BIOMETHANE 3000 system and is the responsibility of the operator.

- The gas exhaust line should be returned to a suitable location at the required point. It is recommended that a valve be incorporated in the assembly so that the gas can be shut off if the sample line is removed. See [Figure 9 - Ball valve assembly](#).



The gas being exhausted at this point of the system will be flowing at approximately 300cc/min (300ml/min). If the sample gas is being vented to atmosphere, it should be routed to a safe and well-ventilated area.

- An additional ball valve should be incorporated in to the piping close to the BIOMETHANE 3000 system, even when being vented to atmosphere. This ball valve will be used as part of pressure testing the system during routine maintenance.
- The gas exhaust line should be connected to the bulkhead connector labelled 'PROCESS RETURN' – see annotation 7 on [Figure 5 - BIOMETHANE 3000 customer connections](#).
- The process return line should ideally be within  $\pm 30\text{mbar}$  ( $\pm 0.9\text{ in. H}_2\text{O}$ ,  $\pm 0.44\text{ psi}$ ) of standard atmospheric pressure, and must always be lower than the sample gas or auto-calibration inlet pressure to avoid system damage.

### Auto-Calibration In

This is the line where gas from the auto-calibration enclosure is connected. Gas will be supplied to the system at user definable intervals in order to calibrate at the location's environmental conditions to maintain accuracy.

- As the auto-calibration enclosure must be positioned in a non-hazardous area, the gas line will need routing to the BIOMETHANE 3000 system. It is recommended that a valve be incorporated in the assembly so that the gas can be shut off if the line is removed.
- An additional ball valve should be incorporated in to the gas line close to the BIOMETHANE 3000 system. This ball valve will be used to isolate the gas supply to the system as part of pressure testing the system during routine maintenance.
- The sample tube should be connected to the bulkhead connector labelled 'AUTO-CAL IN' – see annotation 10 on [Figure 5 - BIOMETHANE 3000 customer connections](#).

## Operating Manual

Note: There is no maximum distance that the auto-calibration equipment can be situated from the BIOMETHANE 3000 system. However, a distance greater than three metres could induce noise on the cable. See [How to Wire the Supply for the Auto-Calibration Pressure Transducer](#).

Note: Timings can be adjusted to allow for distance in the [Auto-Calibration Settings](#) menu option.

### Air In

The air purge inlet requires uncontaminated air for the purge line. If uncontaminated air is available, the particulate filter should remain in place.

If uncontaminated air cannot be guaranteed at the location of the analyzer, the particulate filter should be removed and a pipe should be connected in its place and terminated at a point where uncontaminated air is present. The sample tube should be connected to the bulkhead connector labelled 'AIR IN' – see annotation 6 on [Figure 5 - BIOMETHANE 3000 customer connections](#).

### Vent to Atmosphere



When performing an air purge the gas that was previously sampled will be vented to atmosphere for a short period, typically 10 seconds. This equates to approximately 50ml of gas per air purge. In addition, when performing a user calibration, the calibration gas will be exhausted from this bulkhead. It is therefore recommended that the 'Vent to Atmosphere' line should be routed to a safe and well-ventilated area.

- A ball valve should be incorporated in to the piping close to the BIOMETHANE 3000 system. This ball valve will be used as part of pressure testing the system during routine maintenance.
- The sample tube should be connected to the bulkhead connector labelled 'VENT TO ATMOSPHERE' – see annotation 9 on [Figure 5 - BIOMETHANE 3000 customer connections](#).

### Drain

The system incorporates a catchpot and drain for removal of liquid to help prevent water from entering the system (see annotation 6 on [Figure 2 - BIOMETHANE 3000 internal components](#)). However, additional water filtering may be required where the sample is heavily contaminated with water (available from QED, see part number GA3KP.S15 in section [BIOMETHANE 3000 Consumable Products](#)).

Care should be taken in routing the drain line, especially in cold environments. The drain line may need insulating or even trace heating to prevent freezing of water within the pipe. This is not part of the BIOMETHANE 3000 system and is the responsibility of the operator.

If the auto-drain option is fitted, no manual draining of the system is required.

- The drain line should be connected to the bulkhead connector labelled 'DRAIN' – see annotation 8 on [Figure 5 - BIOMETHANE 3000 customer connections](#).
- The drain line should be run to a position where it is safe to discharge the small amount of liquid that is removed from the sample gas.

## Operating Manual

- The contents of the catchpot are drained under gravity. Therefore, any tubing needs to be lower than the drain compression fitting.
- The drain connection on the system is a 1/4" stainless steel bulkhead connector with a compression fitting suitable for 1/4" outer diameter tubing. It is recommended that stainless steel tubing be used where possible.
- The catchpot contains a liquid level (reed) switch. When the liquid reaches a certain level, the switch activates and informs the BIOMETHANE 3000 module. From here, an icon is displayed on screen and if configured triggers a relay (see [Configure Relays](#)).
- Refer to the [Emptying the Catchpot](#) section of this operating manual for how to drain the catchpot.



The catchpot can hold approximately 3.0 fl oz (90ml) of liquid. Dependent upon the application the liquid removed may be contaminated and should be discharged to an area where it is safe to do so. Alternatively, the contents can be emptied in to a suitable container and disposed of in a safe manner.

This line may also vent sample gas for a brief period during each draining operation if the sample inlet and gas out valves are not closed.

### Connecting the Gas Lines to the Auto-Calibration System

#### Calibration Gas In

**Note:** This gas line is only for use with the non-disposable gas cylinder option chosen at point of manufacture.



The gas being connected to this line will be at high pressure from the main gas bottle. Great care should be taken when using this line so as not to cause a hazard. If in doubt, seek professional advice.

This is the line where gas from the non-disposable cylinder is connected. Gas will be supplied to the auto-calibration system permanently at a pressure set by the regulator and only whilst the gas bottle regulator is open.

- The gas line will need routing from the gas bottle regulator to the auto-calibration system, connected to the bulkhead connector labelled 'CALIBRATION GAS IN' – see annotation 3 on [Figure 6 – Auto-calibration customer connections](#).

#### Calibration Gas Out

This is the line where the calibration gas exits the auto-calibration system and is distributed to the BIOMETHANE 3000 system. Gas will be supplied permanently at a lower pressure set by the secondary regulator and only whilst the gas bottle regulator is open.

- The gas line will need connecting to the bulkhead connector labelled 'CALIBRATION GAS OUT' – see annotations 6 on [Figure 6 – Auto-calibration customer connections](#).

## Operating Manual

- A ball valve should be incorporated in to the piping close to the auto-calibration system. This ball valve will be used as part of pressure testing the system during routine maintenance.

### Over-Pressurization Vents

There are two over-pressurization vents on the auto-calibration system. One is high pressure from the gas bottle and the second is low pressure from the secondary regulator.



In cases of over-pressurization, the pressure relief valve will release gas to protect the equipment. It is critical that the exhaust tubing from the pressure relief valves emerge in a well-ventilated area away from where further hazards could be created.

It is critical that the two over-pressurization vent lines are not joined together, as this could lead to a backpressure that could lead to a failure of the system.

- The gas lines will need connecting to the bulkhead connectors labelled 'VENT (HIGH PRESSURE)' and 'VENT (LOW PRESSURE)' – see annotations 5 and 4 respectively on [Figure 6 – Auto-calibration customer connections](#).

### Protective Cover

The BIOMETHANE 3000 has a protective cover fitted inside the main enclosure to cover areas where mains voltages are present. This cover must be removed in order to wire the mains supply to the BIOMETHANE 3000 system and to replace fuses.



The cover must only be removed when power to the system has been isolated. Failure to isolate the power before removing the cover could result in an electric shock.

It is vital that after installation and prior to powering the equipment that the protective cover is replaced. Failure to replace the cover could result in an electric shock.

The cover is removed by unscrewing four M4 x 12mm button head screws with a 4mm hexagon tool (see [Figure 10 - Mains cover removal](#)). The cover and screws must be kept safe once removed to ensure that they are not lost and can be refitted once installation is complete.

To fit the cover, simply align the holes in the protective cover with the four pillars fixed to the BIOMETHANE 3000 back plate and screw in to place using the 4mm hexagon tool.

**Note:** For clarity, some images of the BIOMETHANE 3000 system in this operating manual may not include the protective cover.

## Operating Manual

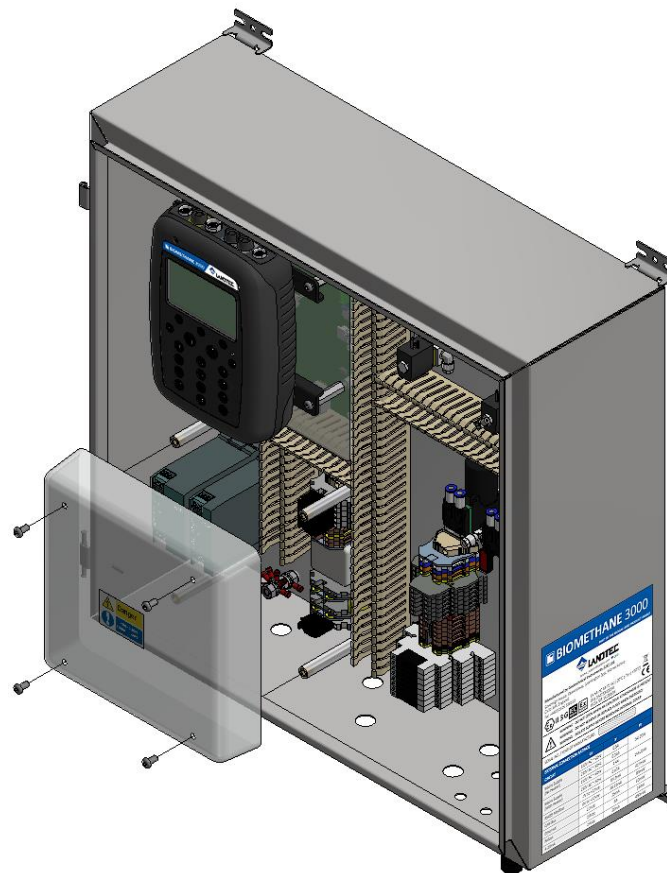

Figure 10 - Mains cover removal

#### Cable Gland Selection and Cord Anchorage

To maintain the integrity and certification of the equipment a cable gland must be selected that:

- is suitably certified – see section Marking in this operating manual for the equipment marking
- has a minimum rating of IP65
- shall be protected against abrasion and sharp bends at the point where the cord enters the equipment, by an inlet or bushing with a smoothly rounded opening
- has been fitted and tightened to the recommended torque set by the manufacturer.



All terminals including unused terminals shall be tightened as per the operating manual.

Failure to meet the above requirements could make the equipment unsafe resulting in a hazard and invalidate the hazardous area certification.



## Operating Manual

In addition, the cable gland must have a means of anchoring the cable. The cord anchorage shall relieve the conductors of the cord from strain, including twisting, where they are connected within the equipment, and shall protect the insulation of the conductors from abrasion. The protective ground conductor shall be last to take the strain if the cord slips in its anchorage.

Cord anchorages shall meet the following requirements:

- The cord shall not be clamped by a screw that bears directly on the cord
- Knots in the cord shall not be used
- It shall not be possible to push the cord into the equipment to an extent that could cause a hazard
- Failure of the cord insulation in a cord anchorage that has metal parts shall not cause accessible conductive parts to become hazardous live
- It shall not be possible to loosen the cord anchorage without the use of a tool
- It shall be designed so that cord replacement does not cause a hazard, and it shall be clear how the relief from strain is provided.



A compression bushing shall not be used as cord anchorage.

Failure to meet the above requirements could make the equipment unsafe resulting in a hazard and invalidate the hazardous area certification.

## Operating Manual

Wiring

Warnings

Only a qualified person should make electrical connections to the system.

Ensure the power is isolated before removing the [Protective Cover](#) to wire the system.

Failure to connect a suitable ground to the system could result in serious injury.

The equipment must be provided with a double-pole switched and fused mains supply.

The switch must be mounted as close to the equipment as practicably possible and clearly identified as the disconnecting device for the system.

Cable glands should meet the requirements of [Cable Gland Selection and Cord Anchorage](#).

Cable insulation and conductor sizes must meet the requirements of [Cable Conductor Sizes and Insulation Requirements](#).



If using armored cable, the armor must not be used as the main ground connection for the BIOMETHANE 3000. If grounding of the armor is required, this must not be taken from the BIOMETHANE 3000.

All cables should be crimped with an appropriate insulated ferrule for the size of the cable being used. In addition, the cable insulation must be housed adequately within the protective sheath of the ferrule.

Terminals that are wired should be tightened to a minimum of 0.6 N·m. Failure to tighten to this requirement could make the equipment unsafe resulting in a hazard and invalidate the hazardous area certification.

The protective cover must be replaced after wiring and before power is applied.

## Operating Manual

### Cable Conductor Sizes and Insulation Requirements

#### Cable Conductor Sizes

Cable conductors must meet the following requirements, be suitable for the environment, and distance to the supply:

Function	Type	Conductor Size	Voltage Rating	Current Rating
Mains supply	Tri-rated	0.14 – 4.0mm <sup>2</sup> solid	230Vac	3.15A
4-20mA outputs	Twisted pair	0.14 – 2.5mm <sup>2</sup> stranded	24Vdc	20mA
Modbus outputs	Twisted pair	0.14 – 4.0mm <sup>2</sup> solid	12Vdc	83.3mA
Relays	Tri-rated	0.14 – 2.5mm <sup>2</sup> stranded	24Vdc	6A
Ethernet	Cat6 (min.)	As per IEEE 802.3u specification. Shall have cable shielding.		

Use Copper conductors only for field-wiring terminals.



Failure to meet the above requirements could make the equipment unsafe resulting in a hazard and invalidate the hazardous area certification.

#### Cable Insulation Requirements

In addition to the table below, the cable insulation must comply with a recognized standard and have a flammability rating of V1 or better:

Function	Cable Insulation thickness (min)	Insulation temperature rating (min)
Mains supply	0.6mm	75°C / 167°F
4-20mA outputs	0.2mm	
Modbus outputs	0.2mm	
Relays	0.2mm	
Ethernet	0.2mm	



Failure to meet the above requirements could make the equipment unsafe resulting in a hazard and invalidate the hazardous area certification.

#### Protective Grounding and Mains Supply – BIOMETHANE 3000 System

The safety of the BIOMETHANE 3000 gas analysis system depends on it being effectively grounded via the mains supply.

The mains requirement for the system can be found on the side of the enclosure and is shown on [Figure 11 - BIOMETHANE 3000 electrical label](#):

Operating Manual

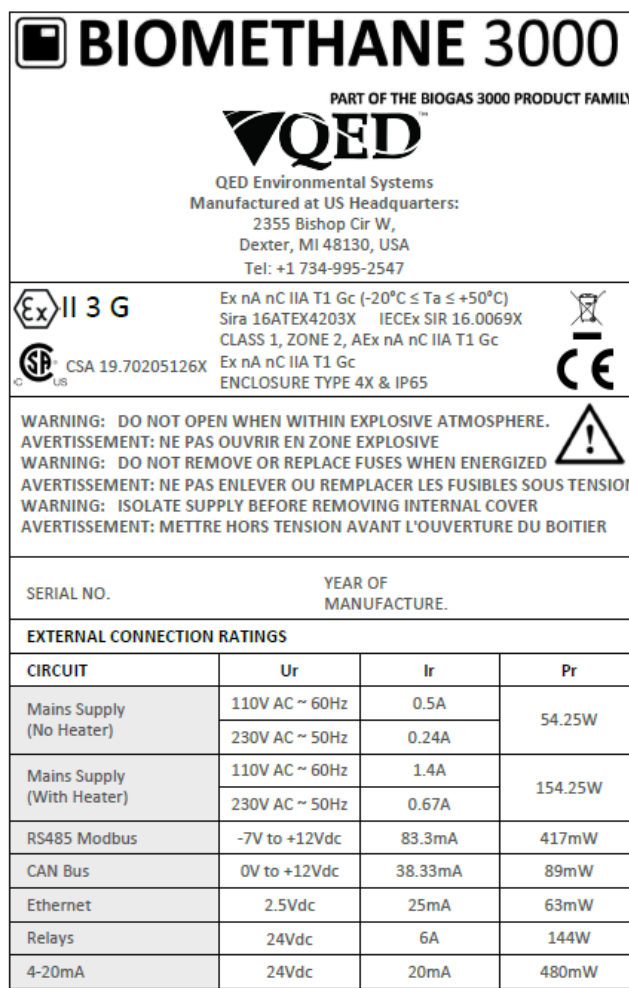

Figure 11 - BIOMETHANE 3000 electrical label

The mains fuse rating (FS1) of the equipment is 3.15A.

The equipment must be provided with a double-pole switched and fused mains supply. The switch must be mounted as close to the equipment as practicably possible so that it can be easily reached and clearly identified as the disconnecting device for the system.

The mains cable must be three core cable (live, neutral and ground) and enter the enclosure via a cable gland (see [Cable Gland Selection and Cord Anchorage](#)) through the mains supply customer cable entry point (see annotation 1 on [Figure 5 - BIOMETHANE 3000 customer connections](#)).

**How to Wire the Mains Supply of the BIOMETHANE 3000 System**

Refer to annotation 15 on [Figure 2 - BIOMETHANE 3000 internal components](#) for the location of the mains wiring terminals, and [Wiring Diagram 1 – Mains](#) for how to wire the mains cable to the BIOMETHANE 3000 system. A label within the system identifies the appropriate inputs live (L), ground (E), and neutral (N).

Operating Manual



Refer to the [Warnings](#) section of this operating manual for a list of requirements to maintain the integrity and certification of the system.

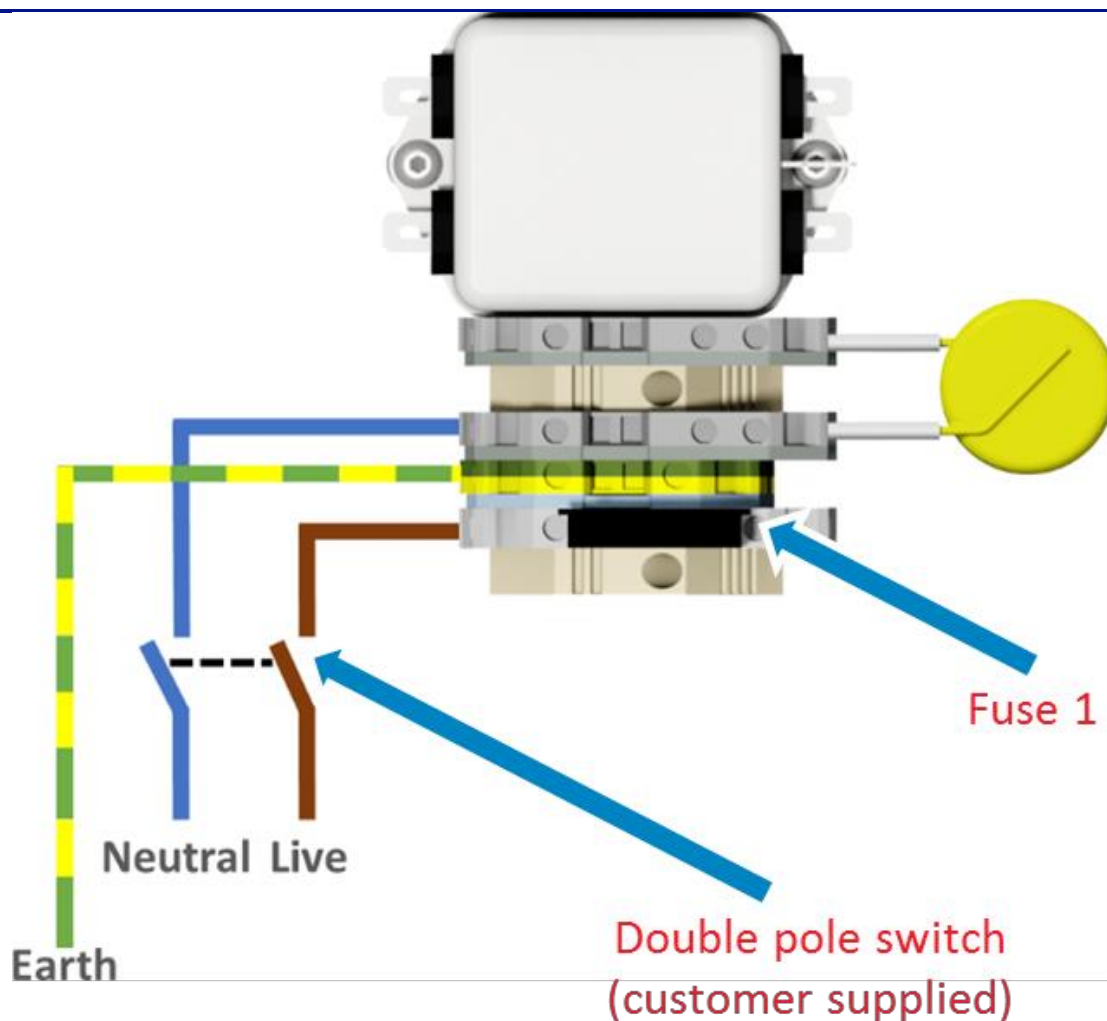

Wiring Diagram 1 – Mains

Note: For cable conductor sizes and cable insulation requirements, please refer to section [Cable Conductor Sizes and Insulation Requirements](#).

**Protective Grounding and Supply Voltage – Auto-Calibration System**

The BIOMETHANE 3000 auto-calibration system does not require a mains supply. The pressure transducer is loop powered by the 24Vdc found within the BIOMETHANE 3000 system.

As voltages within the auto-calibration system should not exceed 24Vdc, it should not be possible for the equipment to become hazardous live, even in wet locations. Therefore, it is not necessary for the auto-calibration system to be grounded. However, if the site’s risk assessment identifies a requirement for the system to be grounded, a ground terminal is available (see annotation 8 on [Figure 3 – Auto-Calibration internal components](#)).

## Operating Manual

### How to Wire the Supply for the Auto-Calibration Pressure Transducer



Refer to the [Warnings](#) section of this operating manual for a list of requirements to maintain the integrity and certification of the system.

For optimum performance, it is recommended that screened twisted pair cable be used. The cable must enter the enclosures via a suitably rated cable gland (see [Cable Gland Selection and Cord Anchorage](#)) and cable (see [Cable Conductor Sizes and Insulation Requirements](#)) through the pressure transducer customer cable entry points (see annotation 11 on [Figure 5 - BIOMETHANE 3000 customer connections](#) and 2 on [Figure 6 – Auto-calibration customer connections](#)).

Refer to annotation 11 on [Figure 2 - BIOMETHANE 3000 internal components](#) for the location of the pressure transducer terminals in the BIOMETHANE 3000 system and annotation 8 on [Figure 3 – Auto-Calibration internal components](#) for the location of the terminals in the auto-calibration system.

Refer to [Wiring Diagram 2 – Pressure transducer](#) for how to wire the pressure transducer from the auto-calibration system to the BIOMETHANE 3000 system. A label within the system identifies the appropriate terminals as '+' and '-'.

Note: For cable conductor sizes and cable insulation requirements, please refer to section [Cable Conductor Sizes and Insulation Requirements](#).

Note: If the pressure transducer cable is greater than three metres in length, noise could be induced into the cable. Therefore, a screened, twisted pair cable is recommended as the interconnection between devices in order to reduce the likelihood of this occurring.

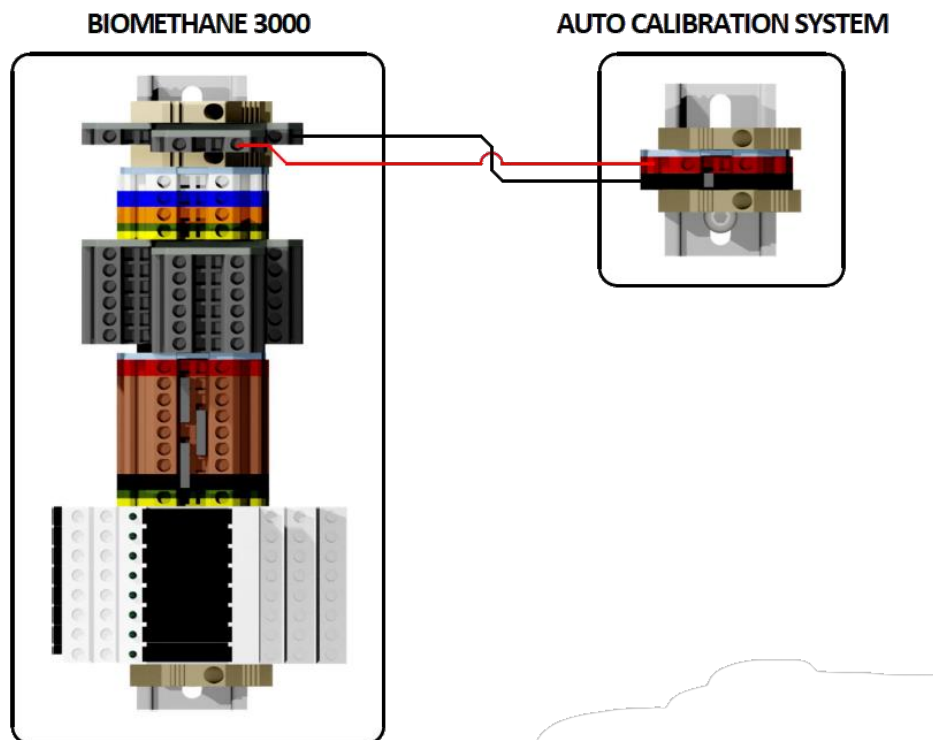

Wiring Diagram 2 – Pressure transducer

## Operating Manual

### How to Wire the Ground for the Auto-Calibration System – if required

As stated, the auto-calibration system should not become hazardous live. However, in the event that a site risk assessment identifies this as a requirement, the facility for the auto-calibration system to be grounded has been provided.



Refer to the [Warnings](#) section of this operating manual for a list of requirements to maintain the integrity and certification of the system.

The ground for the auto-calibration system **must not** be taken from the BIOMETHANE 3000 system. Failure to ground the auto-calibration from an independent location will invalidate the hazardous area certification of the BIOMETHANE 3000.

The ground cable must enter the enclosure via an M12 cable gland (see [Cable Gland Selection and Cord Anchorage](#)) through the ground cable entry point (see annotation 7 on [Figure 6 – Auto-calibration customer connections](#)).

Refer to annotation 8 on [Figure 3 – Auto-Calibration internal components](#) for the location of the ground terminal.

**Note:** For cable conductor sizes and cable insulation requirements, please refer to section [Cable Conductor Sizes and Insulation Requirements](#).

#### Modbus Digital Output

If Modbus digital outputs are being used, the cable must enter the enclosure through the data outputs customer cable entry point (see annotation 3 on [Figure 5 - BIOMETHANE 3000 customer connections](#)).

A label within the system identifies the appropriate outputs '+', '-', and 'LG'. Refer to annotation 12 on [Figure 2 - BIOMETHANE 3000 internal components](#) for the Modbus terminal connections.



The BIOMETHANE 3000 Modbus terminals must only be used for standard Modbus communications. No other connections must be made as they could make the equipment unsafe resulting in a hazard and invalidate the hazardous area certification.

#### Wiring the BIOMETHANE 3000 Modbus Outputs



Refer to the [Warnings](#) section of this operating manual for a list of requirements to maintain the integrity and certification of the system.

Wire the outputs in accordance with [Wiring Diagram 3 – Modbus](#). For optimum performance, it is recommended that screened twisted pair cable be used.

**Note:** For cable conductor sizes and cable insulation requirements, please refer to section [Cable Conductor Sizes and Insulation Requirements](#).

## Operating Manual

When wiring the outputs, the twisted pairs must be as follows:

Terminal Color	Wiring Information	Pair
Orange	Signal A (RS485) '+'	Pair one
Blue	Signal B (RS485) '-'	
White	Logic Ground (0V) 'LG'	Pair two

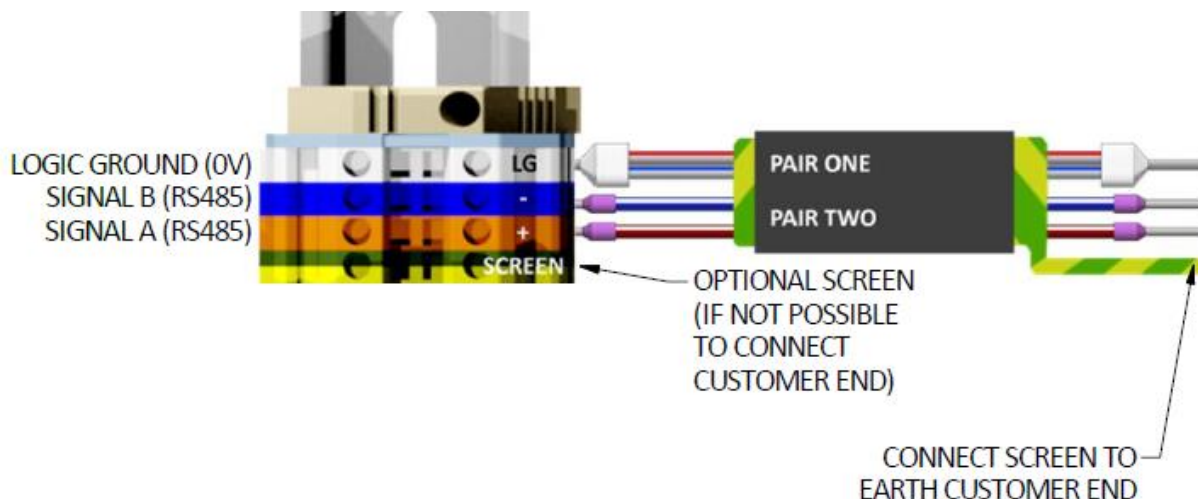

Wiring Diagram 3 – Modbus

### Default Configuration of the BIOMETHANE 3000 Modbus Port

The BIOMETHANE 3000 Modbus port has a default configuration of the following:

Node Address	1
Baud Rate	19200
Parity	Even
Stop Bits	1
Termination	Off
The BIOMETHANE 3000 acts as a slave.	
The protocol is MODBUS RTU.	

Note: A termination resistor of 200 ohms is fitted internally between the positive and negative Modbus signals of the BIOMETHANE 3000, which must be the last connection on the 'bus'. The termination resistor can be turned 'On' or 'Off' via the menu on the BIOMETHANE 3000 module (see [Configure Modbus Slave](#)). Similarly, the master device on the 'bus' should have a termination resistor.

Note: The node address, baud rate, parity, and termination are all configurable settings found within the menu of the BIOMETHANE 3000 module; see section [Configure Modbus Slave](#).



## Operating Manual

### Readable Parameters of the BIOMETHANE 3000

Below is a table of addresses that can be read from the BIOMETHANE 3000.

#### Read-Only Single Bit Registers

Register Address		Parameter	Content information
(Dec)	(Hex)		
0	0000h	System status	0 – system OK 1 – system fault
1	0001h	Flow status	0 – flow OK 1 – flow fail
2	0010h	Communications status	0 – communications OK 1 – communications error
3	0011h	Catchpot status	0 – catchpot empty 1 – catchpot full

#### Read-Only 16-Bit Registers

Register Address		Parameter	Content Information
(Dec)	(Hex)		
0	0000h	Run status	0 – running process 1 – running with non-critical fault 2 – stopped by user (outputs frozen) 3 – stopped by user (fixed at safe values) 4 – stopped with critical fault (outputs frozen)
32	0020h	Time and date: year	e.g. 2016
33	0021h	Time and date: Month	1-12
34	0022h	Time and date: day	1-31
35	0023h	Time and date: hour	0-23
36	0024h	Time and date: minute	0-59
37	0025h	Time and date: second	0-59
48	0030h	Current sample point	0 – Idle 1-4 – Sampling from SPn 65535 – Purge 257 – Main and External Cell (EC) Sampling 65281 – Main Sampling, EC Purging 44034 – AutoCal Sampling Bottle 44287 – AutoCal Purging
128	0080h	Service due: year	e.g. 2016
129	0081h	Service due: month	1-12
130	0082h	Service due: day	1-31
512	0200h	Alarm 1 Status	0 – No alarm 1 – Triggered

Operating Manual

			<p>2 – Triggered and in recovering zone</p> <p>4 – Latched</p> <p>8 – Muted</p> <p>9 – Triggered alarm and muted</p> <p>10 – Recovering alarm and muted</p> <p>12 – Latched and muted</p>
513 to 519	0201h to 0207h	Alarm 2 to alarm 7 Status	Repeated as per alarm 1
768	0300h	Sample point 1 last reading: year	e.g. 2016
769	0301h	Sample point 1 last reading: month	1-12
770	0302h	Sample point 1 last reading: day	1-31
771	0303h	Sample point 1 last reading: hour	0-23
772	0304h	Sample point 1 last reading: minute	0-59
773	0305h	Sample point 1 last reading: second	0-59
800	0320h	SP1 Status: CH <sub>4</sub>	<p>0 – Ok</p> <p>1 – Overrange</p> <p>2 – Underrange</p> <p>3 – Error</p> <p>5 – Calibration Required</p>
801	0321h	SP1 Status: CO <sub>2</sub>	<p>0 – Ok</p> <p>1 – Overrange</p> <p>2 – Underrange</p> <p>3 – Error</p>
802	0322h	SP1 Status: O <sub>2</sub>	Repeated as per SP1 Status:CO <sub>2</sub>
805	0325h	SP1 Status: External cell	Repeated as per SP1 Status:CO <sub>2</sub>
807	0327h	SP1 Status: Baro	Repeated as per SP1 Status:CO <sub>2</sub>
809	0329h	SP1 Status: Flow	Repeated as per SP1 Status:CO <sub>2</sub>
832	0340h	Last reading sample point 1:	CH <sub>4</sub> reading x 10

Operating Manual

		CH4	e.g. 99.9% would be 999
833	0341h	Last reading sample point 1: CO2	CO2 reading x 10 e.g. 0.2% would be 002
834	0342h	Last reading sample point 1: O2	O2 reading x 100 e.g. 0.12% would be 120
837	0345h	Last reading sample point 1: External cell	External cell reading e.g. 3500
839	0347h	Last reading sample point 1: Baro	Baro reading e.g. 1025
841	0349h	Last reading sample point 1: Flow	Pump flow reading e.g. 275
1792	0700h	Auto-Cal Gas Inlet Pressure Status	0 – Ok 1 – Low warning 2 – Empty (too low to calibrate 65535 – Not yet determined
1793	0701h	Last Auto-Cal Result	0 – All passed ok (or not yet run), 1 – One or more channels failed to calibrate 2 – Not completed as bottle is empty 65535 – Not yet run
1794	0702h	Last Auto-Cal O2 status after purge	0 – Ok 1 – Out of range 65535 – Not yet determined
1808	0710h	Last Auto-Cal: Date/Time: Year	e.g. 2016
1809	0711h	Last Auto-Cal: Date/Time: Month	1-31
1810	0712h	Last Auto-Cal: Date/Time: Day	0-23
1811	0713h	Last Auto-Cal: Date/Time: Hour	0-59
1812	0714h	Last Auto-Cal: Date/Time: Minute	0-59
1813	0715h	Last Auto-Cal: Date/Time: Second	1-12
1840	0730h	Before Auto-Cal: CH4	CH4 reading x 10 e.g. 99.9% would be 999
1841	0731h	Before Auto-Cal: CO2	CO2 reading x 10 e.g. 0.2% would be 002
1842	0732h	Before Auto-Cal: O2	O2 reading x 100 e.g. 0.02% would be 002

Operating Manual

1845	0735h	Before Auto-Cal: External Cell 1	External Cell 1 reading e.g. 5ppm would be 5
1846	0736h	Before Auto-Cal: Bottle Pressure	Bottle Pressure e.g. 1.2 Bar would be 1
1856	0740h	After Auto-Cal: CH4	CH4 reading x 10 e.g. 99.9% would be 999
1857	0741h	After Auto-Cal: CO2	CO2 reading x 10 e.g. 0.2% would be 002
1858	0742h	After Auto-Cal: O2	O2 reading x 100 e.g. 0.02% would be 002
1861	0745h	After Auto-Cal: External Cell 1	External Cell 1 reading e.g. 5ppm would be 5
1862	0746h	After AutoCal: Bottle Pressure	Bottle Pressure e.g. 1.2 Bar would be 1
1872	0750h	After AutoCal Purge: O2	O2 reading x 100 e.g. 15% would be 1500

## Operating Manual

### Read-Only 32-Bit Registers

Readings stored in two 16-bit read-only registers as a single precision real/floating point number:

Register Address		Parameter	Content Information
(Dec)	(Hex)		
33024	8100h	Last reading sample point 1: CH4	CH4 reading e.g. 99.9% would be 99.9
33026	8102h	Last reading sample point 1: CO2	CO2 reading e.g. 0.2% would be 0.2
33028	8104h	Last reading sample point 1: O2	O2 reading e.g. 0.02% would be 0.02
33034	810Ah	Last reading sample point 1: External cell	External cell reading e.g. 5ppm would be 5
33038	810Eh	Last reading sample point 1: Baro	Baro reading e.g. 1025
33042	8112h	Last reading sample point 1: Flow	Pump flow reading e.g. 275
61440	F000h	Before Auto-Cal: CH4	CH4 reading e.g. 99.9% would be 999
61442	F002h	Before Auto-Cal: CO2	CO2 reading e.g. 0.2% would be 0.2
61444	F004h	Before Auto-Cal: O2	O2 reading e.g. 0.02% would be 0.02
61450	F00Ah	Before Auto-Cal: External Cell 1	External Cell 1 e.g. 5ppm would be 5
61452	F00Ch	Before Auto-Cal: Bottle Pressure	Bottle Pressure e.g. 1.2 Bar would be 1.2
61472	F020h	After Auto-Cal: CH4	CH4 reading e.g. 99.9% would be 999
61474	F022h	After Auto-Cal: CO2	CO2 reading e.g. 0.2% would be 0.2
61476	F024h	After Auto-Cal: O2	O2 reading e.g. 0.02% would be 0.02
61482	F02Ah	After Auto-Cal: External Cell 1	External Cell 1 e.g. 5ppm would be 5
61484	F02Ch	After Auto-Cal: Bottle Pressure	Bottle Pressure e.g. 1.2 bar would be 1.2
61504	F040h	After Auto-Cal: O2	O2 reading e.g. 15% would be 15

**Note:** Floating-point numbers consist of two 16-bit words to give a 32-bit single precision floating point number. The first word (e.g. 33802) holds the sign in bit 15, the exponent in bits 14-7, part of the mantissa in bits 6-0. The remaining part of the mantissa is in the next register (e.g. 33803) bits 15-0.

## Operating Manual

### 4-20mA Outputs

If analog outputs are being used, the cable must enter the BIOMETHANE 3000 enclosure through the data outputs customer cable entry point (see annotation 3 on [Figure 5 - BIOMETHANE 3000 customer connections](#)).

The outputs on the BIOMETHANE 3000 power the loop (24V) to allow the customers system to sink it to ground (0V).

Relays within the equipment can be used to indicate the status of the 4-20mA channel. Refer to section [Configure Relays](#) for more information.

**Note:** There are various combinations of configuring the system and this operating manual will describe the most common method. If your system does not support this, please contact your local distributor or our technical support team at QED at (800) 624-2026 or email [service@qedenv.com](mailto:service@qedenv.com).

### General Information

There are two sets of terminals for the 4-20mA signals. One set is a bank of terminals that provide a common 0V or 24V. The other group are double-deck terminals that provide the analog signal depending on the configuration of the common terminal.

For the common terminals, labels identify the appropriate terminals namely from left to right ('0V', 'T1' through 'T6', '24V'). 'T1' to 'T6' are commoned together using a 3-way bridge connector between either the '0V' or the '24V' terminal.

For the analog channels, labels identify the appropriate terminal on the double-deck namely:

- Top deck: 'CH1A' through 'CH6A'
- Bottom deck: 'CH1B' through 'CH6B'

Refer to annotation 14 in [Figure 2 - BIOMETHANE 3000 internal components](#) for the terminal location and [Wiring Diagram 4 - 4-20mA circuit](#) for the 4-20mA terminal identification.

### Wiring the BIOMETHANE 3000 to a Current Sinking Input

For this method, the power to the loop is provided by the BIOMETHANE 3000. The BIOMETHANE 3000 sources the current.



Refer to the [Warnings](#) section of this operating manual for a list of requirements to maintain the integrity and certification of the system.

Wire the outputs in accordance with [Wiring Diagram 4 - 4-20mA circuit](#). For optimum performance, it is recommended that screened twisted pair cable be used.

**Note:** For cable conductor sizes and cable insulation requirements, please refer to section [Cable Conductor Sizes and Insulation Requirements](#).

Operating Manual

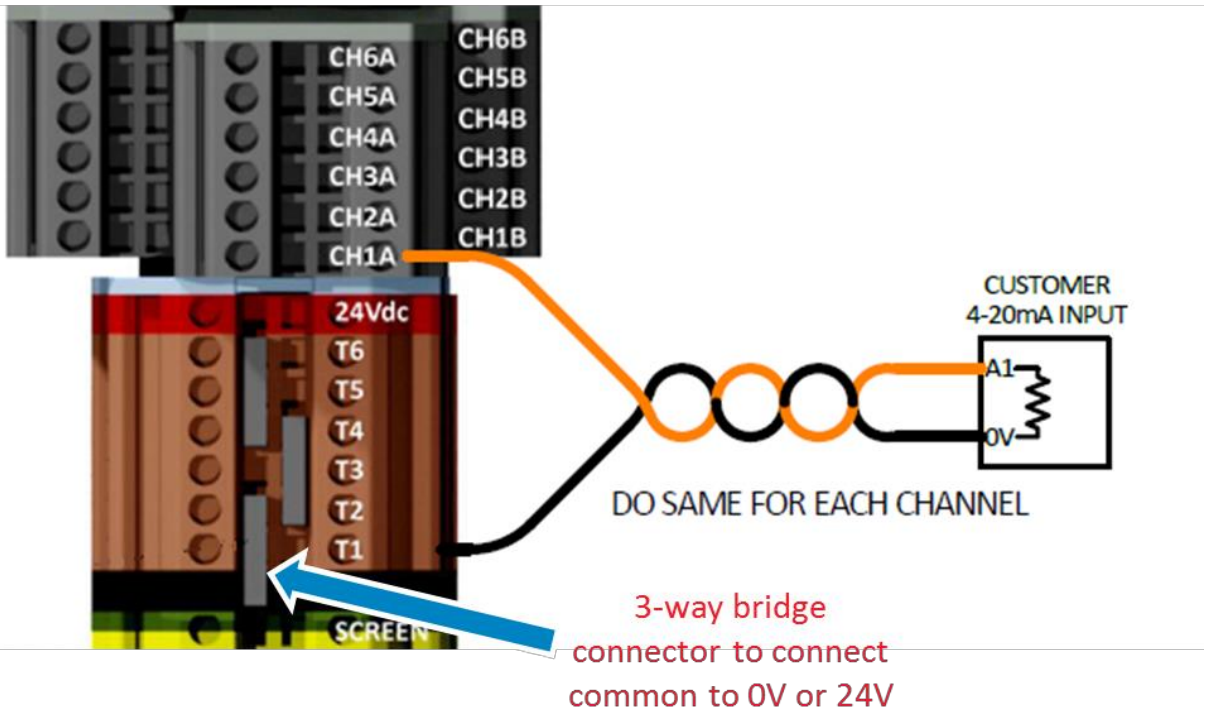
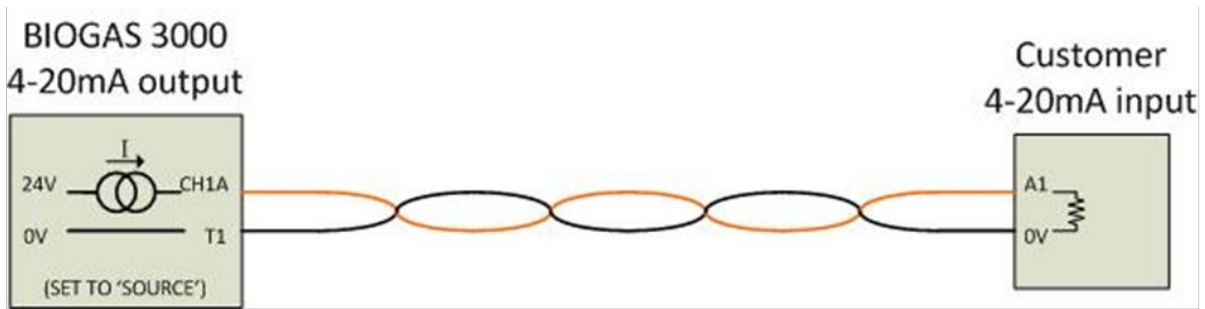

Wiring Diagram 4 - 4-20mA circuit

Note: For wiring into a current source system, please contact your local distributor or our technical support team at QED at (800) 624-2026 or email [service@qedenv.com](mailto:service@qedenv.com).

## Operating Manual

### 4-20mA Scaling

The following table details the scaling on the 4-20mA channels:

Gas	4 mA reading	20 mA reading
CH4	0.0%	100.0%
CO2	0.0%	100.0%
O2	0.0%	25.0%
H2S 0-50ppm	0ppm	50ppm
H2S 0-200ppm	0ppm	200ppm
H2S 0-500ppm	0ppm	500ppm
H2S 0-1,000ppm	0ppm	1,000ppm
H2S 0-5,000ppm	0ppm	5,000ppm
H2S 0-10,000ppm	0ppm	10,000ppm
H2S 0-40,000ppm	0ppm	39,999ppm
H2 0-1,000ppm	0ppm	1,000ppm
CO 0-1,000ppm	0ppm	1,000ppm

In the event of a fault condition on the channel or the channel reading outside its normal range, the 4-20mA output will be as follows:

Fault Condition	4-20mA reading	Gas Readings Screen display
Error	2.5 mA	****
Under range	3.0 mA	<<<<
Over range	3.8 mA	>>>>

### Relays

Note: The relays are configurable for alarm notifications, sample point monitoring notifications, air purge notifications, catchpot full notifications, auto-calibration result, and 4-20mA signal notifications. The configuration is set-up via the menu (see section [Configure Relays](#)).



Refer to the [Warnings](#) section of this operating manual for a list of requirements to maintain the integrity and certification of the system.

The system comes equipped with eight available relays. The relays are volt free changeover contacts. The maximum rated voltage is 24Vdc.

When being used for alarms, auto-calibration result, and fault notifications the relays are normally energized (i.e. will de-energize when an alarm condition is triggered). This means wiring across connections 11 and 12 during a notification will complete the circuit and de-energize the relay. Refer to [Wiring Diagram 5 – Relays](#) for further information.

When being used for sample point indication, catchpot notifications and air purge notifications, the



## Operating Manual

relays are normally de-energized (i.e. will energize when the condition is active). This means wiring across connections 11 and 14 during a notification will complete the circuit and energize the relay. Refer to [Wiring Diagram 5 – Relays](#) for further information.

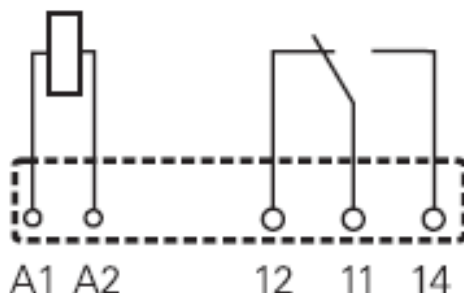

Wiring Diagram 5 – Relays

**Note:** For terminal conductor sizes and cable insulation requirements, please refer to section [Cable Conductor Sizes and Insulation Requirements](#).

### Profibus Digital Output

The Profibus option for the BIOMETHANE 3000 is via a Modbus to Profibus converter module. The converter is a Profibus slave module and acts as an interface between the Modbus output of the BIOMETHANE 3000 and Profibus network.



The Modbus to Profibus converter module for the BIOMETHANE 3000 is not ATEX or IECEx certified and must be housed in a non-hazardous location or within a flameproof enclosure. This is the responsibility of the owner of the equipment.

The BIOMETHANE 3000 Modbus terminals must only be used for standard Modbus communications; no other connections must be made. Connections outside of this could make the equipment unsafe resulting in a hazard and invalidate the hazardous area certification.

**Note:** The Profibus module can be purchased as a post-sale accessory and upgraded on site by the user; see QED part number BG3K.S3 in [BIOMETHANE 3000 Consumable Products](#).

### Configuration of the Profibus Module

The Profibus module node address is currently set to '02'. This can be adjusted, if required, by using the small rotary switches underneath a cap found on the front face of the module (see [Figure 12 - Profibus module switch location](#)). The '0' is set using switch 'A' and the '2' is set using switch 'B' (see [Figure 13 - Profibus module switch identification](#)).

**Note:** The Profibus configuration GSD file required for setting up the master Profibus communications is enclosed on the supplied CD.

Operating Manual



Figure 12 - Profibus module switch location



Figure 13 - Profibus module switch identification

In addition, the Modbus port on the BIOMETHANE 3000 must be configured as followed:

Node Address	1
Baud Rate	9600
Parity	Even
Stop Bits	1
Termination	On
The BIOMETHANE 3000 acts as a slave.	

To configure the Modbus port on the BIOMETHANE 3000, refer to section [Configure Modbus Slave](#) in this operating manual.

Wiring the Profibus Module



Refer to the [Warnings](#) section of this operating manual for a list of requirements to maintain the integrity and certification of the system.

Wire the outputs in accordance with [Wiring Diagram 6 – Modbus to Profibus converter module wiring](#). In addition, [Wiring Diagram 3 – Modbus](#) may also be useful for wiring to the BIOMETHANE 3000 Modbus outputs.

For optimum performance, it is recommended that screened twisted pair cable be used.

**Note:** If the distance between the BIOMETHANE 3000 and the Profibus converter module is greater than 656ft (200m), it may be necessary to add a termination resistor at the Profibus end to ensure noise-free communications. In this case, place a 200ohms (0.25W) resistor across the two data line terminals pins one and two on the Furse ESP SL06/I.

Operating Manual

For further information please contact your local distributor or our technical support team at QED at (800) 624-2026 or email [service@qedenv.com](mailto:service@qedenv.com).

For cable conductor sizes and cable insulation requirements, when wiring the Modbus connections, the twisted pairs must be as follows:

Terminal Color	Wiring Information	Pair
Orange	Signal A (RS485) '+'	Pair one
Blue	Signal B (RS485) '-'	
White	Logic Ground (0V) 'LG'	Pair two

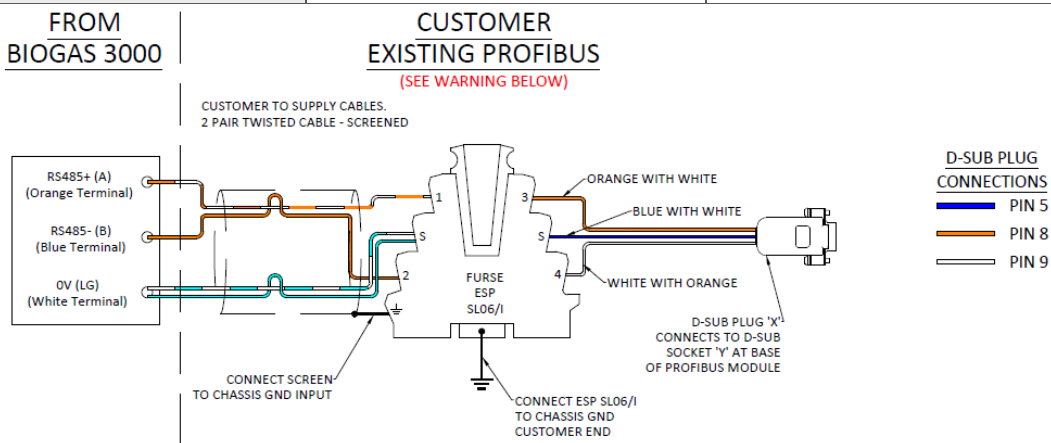

**BASE OF PROFIBUS MODULE**

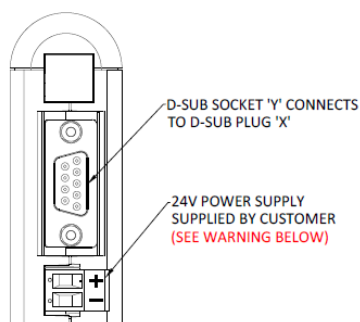

**FRONT OF PROFIBUS MODULE**

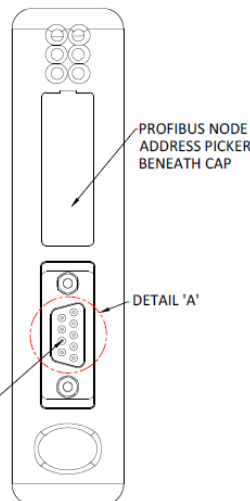

**VIEW OF DETAIL 'A'**

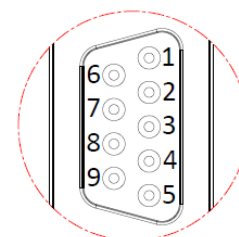

Pin No	Input/Output
1	N/A
2	N/A
3	B-Line Rx/Tx
4	RTS
5	GND Bus (Output)
6	+5 Bus (Output)
7	N/A
8	A-Line Rx/Tx
9	N/A

**WARNING:**

The 24Vdc supply must not be from the BIOGAS 3000 system. Taking this supply voltage from the BIOGAS 3000 will invalidate the ATEX & IECEx certification. The Modbus to Profibus converter module is not ATEX or IECEx Certified and must be housed in a non-hazardous location or within a flameproof enclosure.

**NOTE:**

D-SUB PLUG 'X' AND CABLE ASSEMBLY CONTAINS AN EMBEDDED RESISTOR NETWORK AND IS SUPPLIED WITH THE PROFIBUS MODULE KIT

PROFIBUS CONNECTOR FROM EXISTING NETWORK TO BE SUPPLIED BY CUSTOMER

Wiring Diagram 6 – Modbus to Profibus converter module wiring

## Operating Manual

### Readable Parameters of the Profibus Module

The data available to the Profibus network is two (16-bit) words, each word occupying two hex address locations as follows:

Module Internal Name	Parameter	Example
0x0000	Sample Point 1 Last Reading: Year	e.g. 0x07E0 (2016 dec) is 2016 or High Byte 7x256 +Low Byte 0x224
0x0002	Sample Point 1 Last Reading: Month	
0x0004	Sample Point 1 Last Reading: Day	
0x0006	Sample Point 1 Last Reading:	
0x0008	Sample Point 1 Last Reading:	
0x000A	Sample Point 1 Last Reading: Second	
0x000C	Sample Point 1 Last Reading: CH4 x 10	e.g. 0x0259 (601 dec) is 60.1% or High Byte 2x256 +Low Byte 0x89
0x000E	Sample Point 1 Last Reading: CO2 x 10	
0x0010	Sample Point 1 Last Reading: O2 x 10	
0x0014	Sample Point 1 Last Reading: External Cell	
0x0016	Sample Point 1 Last Reading: Gas Flow	e.g. 0x0122 (290 dec) is 290cc/min (290ml/min) or High Byte 1x256 +Low Byte 0x34
0x0018	Barometric Pressure	e.g. 0x03E1 (993 dec) is 993mbar or High Byte 3x256 +Low Byte 0x225
0x0062	Alarm 1	0= No Alarm,
0x0064	Alarm 2	1=Triggered,
0x0066	Alarm 3	2=Triggered and in recovery zone
0x0068	Alarm 4	4 = Latched
0x006A	Alarm 5	8 = Muted
0x006C	Alarm 6	9 = Triggered alarm and muted
0x006E	Alarm 7	A = Recovering alarm and muted
0x0082	Auto Calibration Cylinder Pressure Status	0 – Ok 1 – Low warning 2 – Empty (too low to calibrate) 65535 – Not yet determined
0x0084	Last Auto Calibration Result	0 – All passed ok (or not yet run),

Operating Manual

		1 – One or more channels failed to calibrate 2 – Not completed as bottle is empty 65535 – Not yet run
0x0086	Auto Calibration O2 Status Post Purge	0 – Ok 1 – Out of range 65535 – Not yet determined
0x0088	Last Auto Calibration: Year	e.g. 0x07E0 (2016 dec) is 2016 or High Byte 7x256 +Low Byte 0x224
0x008A	Last Auto Calibration: Month	
0x008C	Last Auto Calibration: Day	
0x008E	Last Auto Calibration: Hour	
0x0090	Last Auto Calibration: Minute	
0x0092	Last Auto Calibration: Second	
0x0094	Before Auto-Cal: CH4	e.g. 0x0259 (601 dec) is 60.1% or High Byte 2x256 +Low Byte 0x89
0x0096	Before Auto-Cal: CO2	
0x0098	Before Auto-Cal: O2	
0x009A	Before Auto-Cal: External Cell 1	e.g. 0x03E8 (1000 dec) is 1000ppm or High Byte 3x256 +Low Byte 0x232
0x009C	After Auto-Cal: CH4	e.g. 0x0259 (601 dec) is 60.1% or High Byte 2x256 +Low Byte 0x89
0x009E	After Auto-Cal: CO2	
0x00A0	After Auto-Cal: O2	
0x00A2	After Auto-Cal: External Cell 1	e.g. 0x03E8 (1000 dec) is 1000ppm or High Byte 3x256 +Low Byte 0x232
0x00B0	Cylinder Pressure: Pre-Calibration	e.g. 0x001A (26 dec) is 2.6BarG or High Byte 0x256 +Low Byte 0x26
0x00B2	Cylinder Pressure: Post-Calibration	

## Operating Manual

The Profibus module updates the readings from the BIOMETHANE 3000 every 2.5 seconds.

Successful communication between the Modbus output and the Profibus module is indicated by the subnet status light '5' on the module showing green. If for any reason the communications is intermittent or fails, the light flashes red or is permanently red, and the value being read is cleared to zero and not frozen with a previous value. Monitoring for an example the year, month and day for non-zero values will gain confidence that communications is ongoing.

### Profinet Digital Output

The Profinet option for the BIOMETHANE 3000 is via a Modbus to Profinet converter module. The converter is a Profinet slave module and acts as an interface between the Modbus output of the BIOMETHANE 3000 and Profinet network.



The Modbus to Profinet converter module for the BIOMETHANE 3000 is not ATEX or IECEx certified and must be housed in a non-hazardous location or within a flameproof enclosure. This is the responsibility of the owner of the equipment.

The BIOMETHANE 3000 Modbus terminals must only be used for standard Modbus communications; no other connections must be made. Connections outside of this could make the equipment unsafe resulting in a hazard and invalidate the hazardous area certification.

**Note:** The Profinet module can be purchased as a post-sale accessory and upgraded on site by the user, see QED part number BG3K.S4 in [BIOMETHANE 3000 Consumable Products](#).

### Configuration of the Profinet Module

The Profinet module can be configured using the GSDML file supplied on the enclosed CD. Follow the instructions on the supplied installation sheet to configure the module for the Profinet sub-network.

In addition, the Modbus port on the BIOMETHANE 3000 must be configured as followed:

Node Address	1
Baud Rate	9600
Parity	Even
Stop Bits	1
Termination	On
The BIOMETHANE 3000 acts as a slave.	

To configure the Modbus port on the BIOMETHANE 3000, refer to section [Configure Modbus Slave](#) in this operating manual.

## Operating Manual

### Wiring the Profinet Module



Refer to the [Warnings](#) section of this operating manual for a list of requirements to maintain the integrity and certification of the system.

Wire the outputs in accordance with [Wiring Diagram 7 - Modbus to Profinet converter module wiring](#).

In addition, [Wiring Diagram 3 – Modbus](#) may also be useful for wiring to the BIOMETHANE 3000 Modbus outputs.

For optimum performance, it is recommended that screened twisted pair cable be used.

**Note:** If the distance between the BIOMETHANE 3000 and the Profinet converter module is greater than 200m, it may be necessary to add a termination resistor at the Profinet end to ensure noise-free communications. In this case, place a 200ohms (0.25W) resistor across the two data line terminals pins one and two on the Furse ESP SL06/I.

For further information please contact your local distributor or our technical support team at QED at (800) 624-2026 or email [service@qedenv.com](mailto:service@qedenv.com).

When wiring the Modbus connections, the twisted pairs must be as follows:

Terminal Color	Wiring Information	Pair
Orange	Signal A (RS485) '+'	Pair one
Blue	Signal B (RS485) '-'	
White	Logic Ground (0V) 'LG'	Pair two

Operating Manual

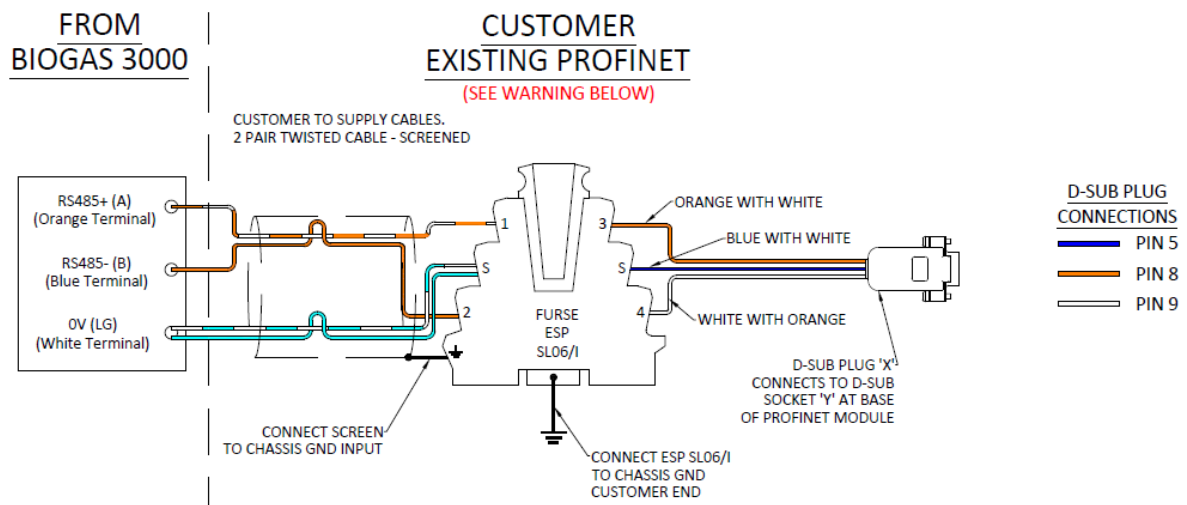

**BASE OF PROFINET MODULE**

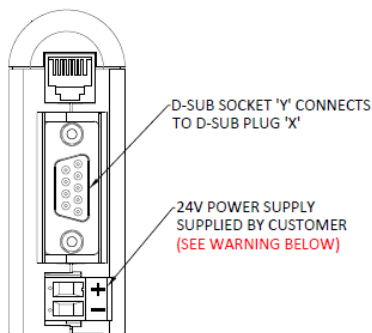

**FRONT OF PROFINET MODULE**

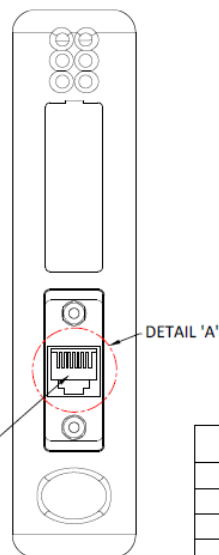

**VIEW OF DETAIL 'A'**

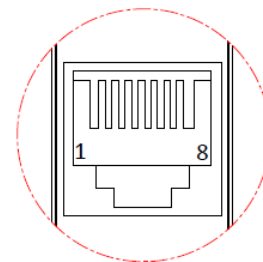

**WARNING:**

The 24Vdc supply must not be from the BIOGAS 3000 system. Taking this supply voltage from the BIOGAS 3000 will invalidate the ATEX & IECEx certification. The Modbus to Profibus converter module is not ATEX or IECEx Certified and must be housed in a non-hazardous location or within a flameproof enclosure.

Profibus Module Pin Details	
Pin No	Input/Output
1	TD+
2	TD-
3	RD+
6	RD-
4, 5, 7, 9	Termination

**NOTE:**

D-SUB PLUG 'X' AND CABLE ASSEMBLY IS SUPPLIED WITH THE PROFINET MODULE KIT

PROFINET CONNECTOR FROM EXISTING NETWORK TO BE SUPPLIED BY CUSTOMER

Wiring Diagram 7 - Modbus to Profinet converter module wiring



## Operating Manual

### Readable Parameters of the Profinet Module

The data available to the Profinet network is two (16-bit) words, each word occupying two hex address locations as follows:

Module Internal Name	Parameter	Example
0x0000	Sample Point 1 Last Reading: Year	e.g. 0x07E0 (2016 dec) is 2016 or High Byte 7x256 +Low Byte 0x224
0x0002	Sample Point 1 Last Reading: Month	
0x0004	Sample Point 1 Last Reading: Day	
0x0006	Sample Point 1 Last Reading:	
0x0008	Sample Point 1 Last Reading:	
0x000A	Sample Point 1 Last Reading: Second	
0x000C	Sample Point 1 Last Reading: CH4 x 10	e.g. 0x0259 (601 dec) is 60.1% or High Byte 2x256 +Low Byte 0x89
0x000E	Sample Point 1 Last Reading: CO2 x 10	
0x0010	Sample Point 1 Last Reading: O2 x 10	
0x0014	Sample Point 1 Last Reading: External Cell 1	
0x0016	Sample Point 1 Last Reading: Gas Flow	e.g. 0x0122 (290 dec) is 290cc/min (290ml/min) or High Byte 1x256 +Low Byte 0x34
0x0018	Barometric Pressure	e.g. 0x03E1 (993 dec) is 993mbar or High Byte 3x256 +Low Byte 0x225
0x0062	Alarm 1	0= No Alarm,
0x0064	Alarm 2	1=Triggered,
0x0066	Alarm 3	2=Triggered and in recovery zone
0x0068	Alarm 4	4 = Latched
0x006A	Alarm 5	8 = Muted
0x006C	Alarm 6	9 = Triggered alarm and muted
0x006E	Alarm 7	A = Recovering alarm and muted
0x0082	Auto Calibration Cylinder Pressure Status	0 – Ok 1 – Low warning 2 – Empty (too low to calibrate) 65535 – Not yet determined
0x0084	Last Auto Calibration Result	0 – All passed ok (or not yet run), 1 – One or more channels failed to calibrate

Operating Manual

		2 – Not completed as bottle is empty 65535 – Not yet run
0x0086	Auto Calibration O2 Status Post Purge	0 – Ok 1 – Out of range 65535 – Not yet determined
0x0088	Last Auto Calibration: Year	e.g. 0x07E0 (2016 dec) is 2016 or High Byte 7x256 +Low Byte 0x224
0x008A	Last Auto Calibration: Month	
0x008C	Last Auto Calibration: Day	
0x008E	Last Auto Calibration: Hour	
0x0090	Last Auto Calibration: Minute	
0x0092	Last Auto Calibration: Second	
0x0094	Before Auto-Cal: CH4	e.g. 0x0259 (601 dec) is 60.1% or High Byte 2x256 +Low Byte 0x89
0x0096	Before Auto-Cal: CO2	
0x0098	Before Auto-Cal: O2	
0x009A	Before Auto-Cal: External Cell 1	e.g. 0x03E8 (1000 dec) is 1000ppm or High Byte 3x256 +Low Byte 0x232
0x009C	After Auto-Cal: CH4	e.g. 0x0259 (601 dec) is 60.1% or High Byte 2x256 +Low Byte 0x89
0x009E	After Auto-Cal: CO2	
0x00A0	After Auto-Cal: O2	
0x00A2	After Auto-Cal: External Cell 1	e.g. 0x03E8 (1000 dec) is 1000ppm or High Byte 3x256 +Low Byte 0x232
0x00B0	Cylinder Pressure: Pre-Calibration	e.g. 0x001A (26 dec) is 2.6BarG or High Byte 0x256 +Low Byte 0x26
0x00B2	Cylinder Pressure: Post-Calibration	

## Operating Manual

The Profinet module updates the readings from the BIOMETHANE 3000 every 2.5 seconds.

Successful communication between the Modbus output and the Profinet module is indicated by the subnet status light '5' on the module showing green. If for any reason the communications is intermittent or fails, the light flashes red or is permanently red, and the value being read is cleared to zero and not frozen with a previous value. Monitoring for an example the year, month and day for non-zero values will gain confidence that communications is ongoing.

### Ethernet Digital Output

The Ethernet option for the BIOMETHANE 3000 is via a Modbus to Ethernet converter module. The converter is an Ethernet slave module and acts as an interface between the Modbus output of the BIOMETHANE 3000 and Ethernet network.

 The Ethernet Digital module does not grant access to the QED customer portal. To enable remote support functionality, please see section [Wiring the Ethernet Input](#).

 The Modbus to Ethernet converter module for the BIOMETHANE 3000 is not ATEX or IECEx certified and must be housed in a non-hazardous location or within a flameproof enclosure. This is the responsibility of the owner of the equipment.

 The BIOMETHANE 3000 Modbus terminals must only be used for standard Modbus communications; no other connections must be made. Connections outside of this could make the equipment unsafe resulting in a hazard and invalidate the hazardous area certification.

**Note:** The Ethernet module can be purchased as a post-sale accessory and upgraded on site by the user; see QED part number BG3K.S40 in [BIOMETHANE 3000 Consumable Products](#).

### Configuration of the Ethernet Module

The Ethernet module IP address is currently set to 192.168.0.1. This can be changed, if required, by using the software provided via the enclosed CD.

**Note:** The Ethernet configuration EDS file required for setting up the master Ethernet communications is enclosed on the supplied CD.

In addition, the Modbus port on the BIOMETHANE 3000 must be configured as followed:

Node Address	1
Baud Rate	9600
Parity	Even

## Operating Manual

Stop Bits	1
Termination	On
The BIOMETHANE 3000 acts as a slave.	

To configure the Modbus port on the BIOMETHANE 3000, refer to section [Configure Modbus Slave](#) in this operating manual.

### Wiring the Ethernet Module



Refer to the [Warnings](#) section of this operating manual for a list of requirements to maintain the integrity and certification of the system.

Wire the outputs in accordance with [Wiring Diagram 8 – Modbus to Ethernet converter module wiring](#). In addition, [Wiring Diagram 3 – Modbus](#) may also be useful for wiring to the BIOMETHANE 3000 Modbus outputs.

For optimum performance, it is recommended that screened twisted pair cable be used.

**Note:** If the distance between the BIOMETHANE 3000 and the Ethernet converter module is greater than 200m, it may be necessary to add a termination resistor at the Ethernet end to ensure noise-free communications. In this case, place a 200ohms (0.25W) resistor across the two data line terminals pins one and two on the Furse ESP SL06/I.

For further information please contact your local distributor or our technical support team at QED at (800) 624-2026 or email [service@qedenv.com](mailto:service@qedenv.com).

When wiring the Ethernet connections, the twisted pairs must be as follows:

Terminal Color	Wiring Information	Pair
Orange	Signal A (RS485) '+'	Pair one
Blue	Signal B (RS485) '-'	
White	Logic Ground (0V) 'LG'	Pair two

Operating Manual

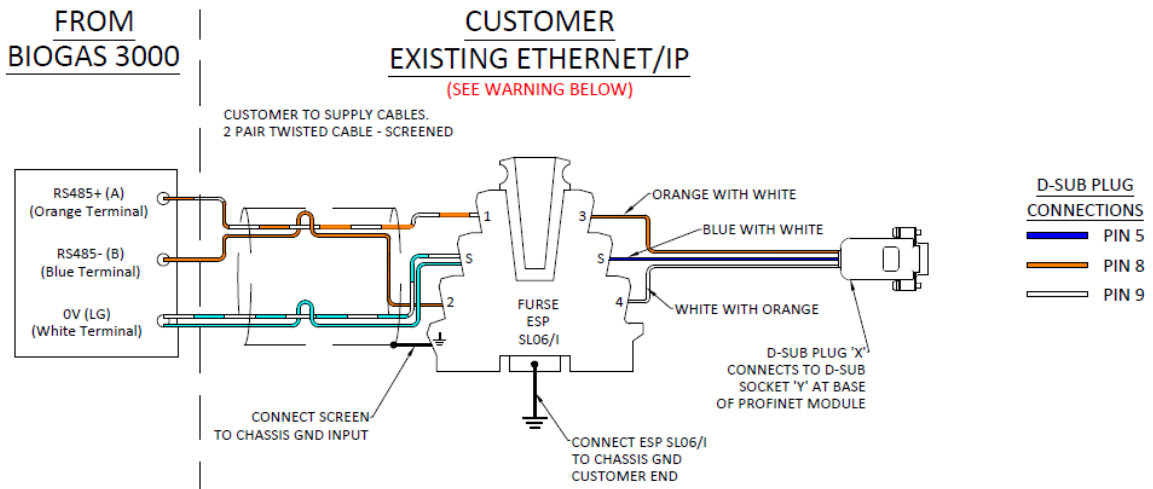

**BASE OF ETHERNET/IP MODULE**

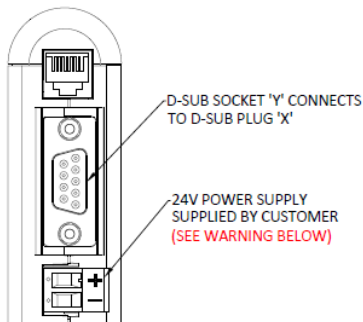

**FRONT OF ETHERNET/IP MODULE**

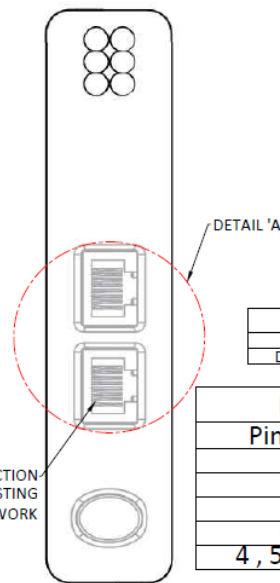

**VIEW OF DETAIL 'A'**

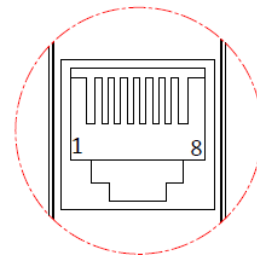

ETHERNET IP CONFIGURATION	
IP ADDRESS	192.168.0.1
DEFAULT GATEWAY	0.0.0.0

Ethernet Module Pin Details	
Pin No	Input/Output
1	TD+
2	TD-
3	RD+
6	RD-
4, 5, 7, 8	Termination



**WARNING:**

The 24Vdc supply must not be from the BIOGAS 3000 system. Taking this supply voltage from the BIOGAS 3000 will invalidate the ATEX & IECEx certification. The Modbus to Ethernet/IP converter module is not ATEX or IECEx Certified and must be housed in a non-hazardous location or within a flameproof enclosure.

**NOTE:**

D-SUB PLUG 'X' AND CABLE ASSEMBLY IS SUPPLIED WITH THE ETHERNET/IP MODULE KIT  
ETHERNET/IP CONNECTOR FROM EXISTING NETWORK TO BE SUPPLIED BY CUSTOMER

Wiring Diagram 8 – Modbus to Ethernet converter module wiring

## Operating Manual

### Readable Parameters of the Ethernet Module

The data available to the Ethernet network is two (16-bit) words, each word occupying two hex address locations as follows:

Module Internal Name	Parameter	Example
0x0000	Sample Point 1 Last Reading: Year	e.g. 0x07E0 (2016 dec) is 2016 or High Byte 07x256 +Low Byte 0x224, EO Hex = 224 dec
0x0002	Sample Point 1 Last Reading: Month	
0x0004	Sample Point 1 Last Reading: Day	
0x0006	Sample Point 1 Last Reading: Hour	
0x0008	Sample Point 1 Last Reading: Minute	
0x000A	Sample Point 1 Last Reading: Second	
0x000C	Sample Point 1 Last Reading: CH4 x 10	e.g. 0x0259 (601 dec) is 60.1% or High Byte 2x256 +Low Byte 0x89
0x000E	Sample Point 1 Last Reading: CO2 x 10	
0x0010	Sample Point 1 Last Reading: O2 x 10	
0x0014	Sample Point 1 Last Reading: External Cell	e.g. 0x03E8 (1000 dec) is 1000ppm or High Byte 3x256 +Low Byte 0x232
0x0016	Sample Point 1 Last Reading: Gas Flow	e.g. 0x0122 (290 dec) is 290cc/min (290ml/min) or High Byte 1x256 +Low Byte 0x34
0x0018	Barometric Pressure	e.g. 0x03E1 (993 dec) is 993mbar or High Byte 3x256 +Low Byte 0x225
0x0062	Alarm 1	0= No Alarm,
0x0064	Alarm 2	1=Triggered,
0x0066	Alarm 3	2=Triggered and in recovery zone
0x0068	Alarm 4	4 = Latched
0x006A	Alarm 5	8 = Muted
0x006C	Alarm 6	9 = Triggered alarm and muted
0x006E	Alarm 7	A = Recovering alarm and muted
0x0082	Auto Calibration Cylinder Pressure Status	0 – Ok 1 – Low warning 2 – Empty (too low to calibrate)

Operating Manual

		65535 – Not yet determined
0x0084	Last Auto Calibration Result	0 – All passed ok (or not yet run), 1 – One or more channels failed to calibrate 2 – Not completed as bottle is empty 65535 – Not yet run
0x0086	Auto Calibration O2 Status Post Purge	0 – Ok 1 – Out of range 65535 – Not yet determined
0x0088	Last Auto Calibration: Year	e.g. 0x07E0 (2016 dec) is 2016 or High Byte 7x256 +Low Byte 0x224
0x008A	Last Auto Calibration: Month	
0x008C	Last Auto Calibration: Day	
0x008E	Last Auto Calibration: Hour	
0x0090	Last Auto Calibration: Minute	
0x0092	Last Auto Calibration: Second	
0x0094	Before Auto-Cal: CH4	e.g. 0x0259 (601 dec) is 60.1% or High Byte 2x256 +Low Byte 0x89
0x0096	Before Auto-Cal: CO2	
0x0098	Before Auto-Cal: O2	
0x009A	Before Auto-Cal: External Cell 1	e.g. 0x03E8 (1000 dec) is 1000ppm or High Byte 3x256 +Low Byte 0x232
0x009C	After Auto-Cal: CH4	e.g. 0x0259 (601 dec) is 60.1% or High Byte 2x256 +Low Byte 0x89
0x009E	After Auto-Cal: CO2	
0x00A0	After Auto-Cal: O2	
0x00A2	After Auto-Cal: External Cell 1	e.g. 0x03E8 (1000 dec) is 1000ppm or High Byte 3x256 +Low Byte 0x232
0x00B0	Cylinder Pressure: Pre-Calibration	e.g. 0x001A (26 dec) is 2.6BarG or High Byte 0x256 +Low Byte 0x26
0x00B2	Cylinder Pressure: Post-Calibration	

## Operating Manual

The Ethernet module updates the readings from the BIOMETHANE 3000 every 2.5 seconds.

Successful communication between the Modbus output and the Ethernet module is indicated by the subnet status light '5' on the module showing green. If for any reason the communications is intermittent or fails, the light flashes red or is permanently red, and the value being read is cleared to zero and not frozen with a previous value.

For example, if the data in the address locations for either minute or second regularly changes, this will give confidence that communications is active and uninterrupted.

### Wiring the Ethernet Input

The Ethernet connector can be used to connect to the internet and gain access to the QED Customer Portal, allowing remote support functionality.

Ensure the power is isolated.

Cable glands should meet the requirements of [Cable Gland Selection and Cord Anchorage](#).

Cable insulation and conductor sizes must meet the requirements of [Cable Conductor Sizes and Insulation Requirements](#)



If using armoured cable, the armour must not be used as the main earth connection for the BIOMETHANE 3000. If earthing of the armour is required, this must not be taken from the BIOMETHANE 3000.

The input voltage range to the BIOMETHANE 3000 Ethernet RJ45 connector must not exceed 2.5Vdc and the current must not exceed 25mA. Operating outside of this range will invalidate the hazardous area certification.

Wire the outputs in accordance with [Wiring Diagram 9 – Ethernet cable](#). The cable must be a minimum specification of Cat6 (or higher), have cable shielding (e.g. F/UTP) and terminate in a shielded RJ45 connector.

Registration and access to the QED Customer Portal is via web address: <https://my.qedenv.com>

For full instructions on using the Portal, please use the Help pages within the portal.

**Note:** For cable conductor sizes and cable insulation requirements, please refer to section [Cable Conductor Sizes and Insulation Requirements](#).

**Note:** A network firewall exception for port 6470 will be required to allow authorized access.



Operating Manual



If an internet connection is established using a third party device (e.g. 3G/4G SIM Modem), all necessary precautions need to be taken to ensure the suitability of this device for use in a potentially explosive atmosphere, and adhering to all local site safety procedures.

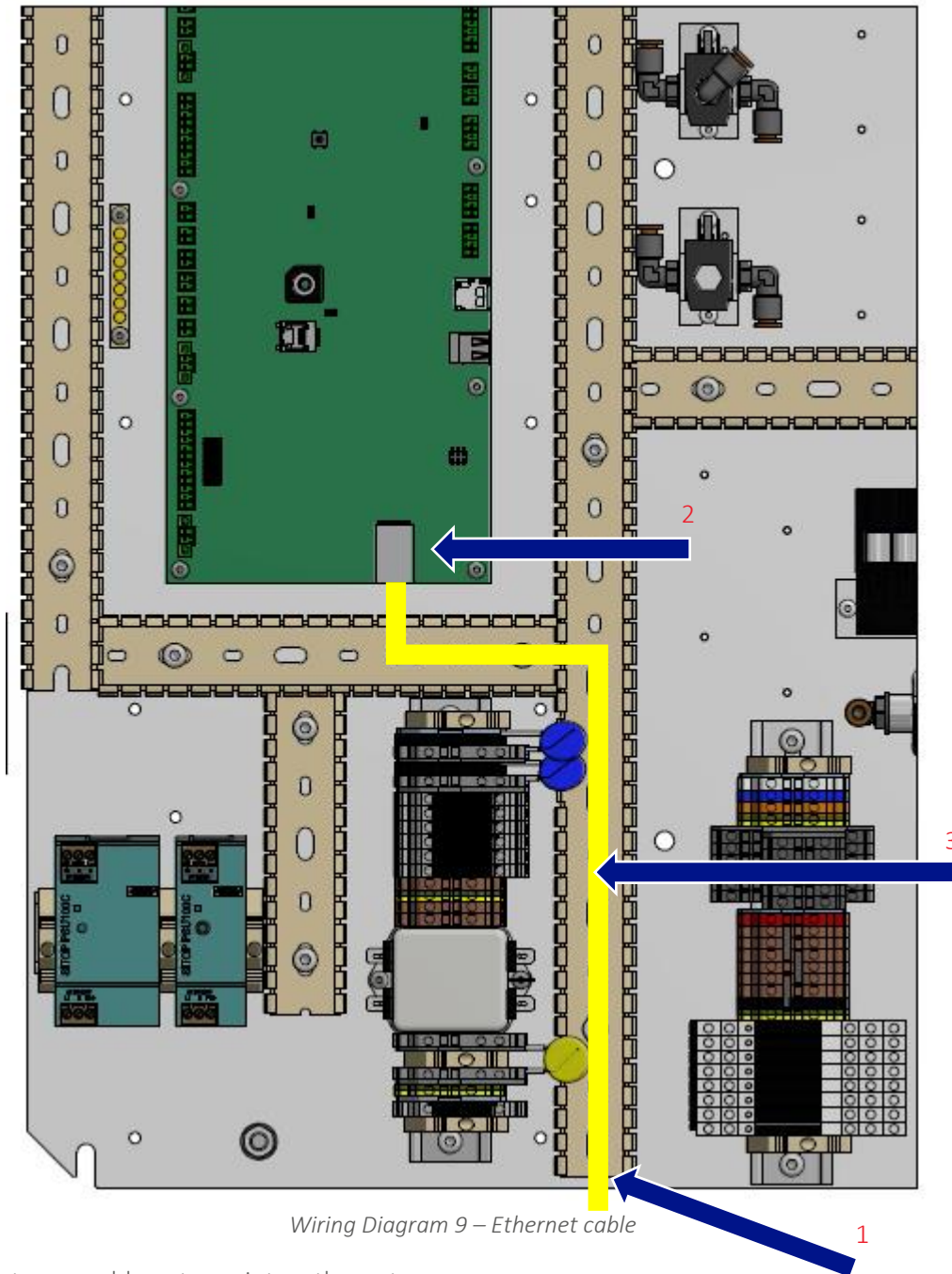

Wiring Diagram 9 – Ethernet cable

- 1) Customer cable entry point – ethernet
- 2) RJ45 connector (interface board)
- 3) Ethernet cable

## Operating Manual

### Heater

The equipment will be fitted with a 100W heater (suitable for the relevant mains input voltage), control thermostat, and enclosure insulation. The thermostat is pre-set to 59°F (15°C) and cannot be adjusted.

### Fitting/Replacing the Disposable Gas Cylinder

The gas being connected to the primary regulator will be at high pressure from the gas bottle. Great care should be taken when making this connection so as not to cause a hazard. If in doubt, seek professional advice.



Ensure that the regulator is fitted to the bottle at arm's length in case of a gas leak.

During the rare occasion that gas does leak from the seal, leave the bottle and regulator and leave the area until the leak has stopped. **DO NOT** attempt to solve the leak as this could be dangerous.

Eye protection should be worn when fitting and removing gas bottle from the system.

For the system with the disposable gas cylinder:

- Ensure the inlet gas valve is in the off position (vertical) – see annotation 4 on [Figure 3 – Auto-Calibration internal components](#).
- Ensure the outlet and bypass valves are in the off position (horizontal) see annotations 6 and 6 respectively on [Figure 3 – Auto-Calibration internal components](#).

**Note:** If replacing a cylinder, remove the existing cylinder by screwing clockwise. A small amount of pressure may release from the connection at the regulator at this point.

- Screw the bottle in to the primary regulator ensuring the C10 fitting is not cross-threaded.
- Open the inlet gas valve (horizontal position) – see annotation 4 on [Figure 3 – Auto-Calibration internal components](#).
- Open the bypass valve (vertical position) – see annotation 6 on [Figure 3 – Auto-Calibration internal components](#). At this point gas will start flowing.
- The primary regulator will be set at point of manufacture, however, if required use the adjustment knob to set the output pressure to a maximum of 4 Bar.
- The flow meter will be set at point of manufacture, however, if required use the adjustment knob to set the flow rate to 300ml/min – see annotation 2 on [Figure 3 – Auto-Calibration internal components](#).
- Close the bypass valve (horizontal position) – see annotation 6 on [Figure 3 – Auto-Calibration internal components](#).

## Operating Manual

- Open the outlet valve (vertical position) – see annotation 5 on [Figure 3 – Auto-Calibration internal components](#). This will allow gas to flow to the BIOMETHANE 3000 system.

### Final Checks

- Ensure all gas connections to the system are leak free – refer to section [Pressure Test](#) of this operating manual for instructions on how to perform this.
- Ensure gas bottle regulator is set to 4 Bar. For the disposable cylinder option, if this needs adjusting, refer to [Fitting/Replacing the Disposable Gas Cylinder](#).
- Ensure the secondary regulator is set to 300mBar. This is factory set but is adjustable should it be required.
- Ensure the gas inlet and gas outlet ball valves are open (refer to annotation 13 on [Figure 2 - BIOMETHANE 3000 internal components](#) and annotation 5 on [Figure 3 – Auto-Calibration internal components](#)) in the BIOMETHANE 3000 system, these must be in the vertical position.
- Ensure the drain ball valve in the BIOMETHANE 3000 system, if fitted, is closed (see annotation 9 on [Figure 2 - BIOMETHANE 3000 internal components](#)), this must be in the horizontal position.
- Ensure the calibration ball valve in the BIOMETHANE 3000 system is closed (see annotation 10 on [Figure 2 - BIOMETHANE 3000 internal components](#)), this must be in the vertical position.
- Ensure the bypass valve in the auto-calibration system is closed (refer to annotation 6 on [Figure 3 – Auto-Calibration internal components](#)). This must be in the horizontal position.
- Ensure the calibration gas out valve in the auto-calibration system is open (refer to annotation 5 on [Figure 3 – Auto-Calibration internal components](#)). This must be in the vertical position.
- Turn the power on to the system. Within one minute of power being applied, the module will turn on and display the BIOMETHANE 3000 logo, shortly followed by the ‘system self-test’ screen (see [Screen 3 - System Self-Test](#)).
- The first time the module is started after the self-test has successfully completed, the ‘first time run set-up wizard’ will begin – please refer to section [First Time Configuration](#) in this manual for details of this process.
- It is strongly recommended that a known concentration of gas be passed through the system to ensure that it is still reading correctly following installation. Refer to the [Gas Check and Calibration](#) section of this operating manual for further information on this process.

Note: For further information please contact your local distributor or our technical support team at QED at (800) 624-2026 or email [service@qedenv.com](mailto:service@qedenv.com).

## Operating Manual

**GENERAL OPERATING INSTRUCTIONS**

Do not open when an explosive atmosphere is present.

**Switching the BIOMETHANE 3000 System On**

- 1) The module will automatically turn on when power to the system is switched on. If this does not happen, refer to the [Problem Solving](#) section of this operating manual.

Note: It can take up to one minute for the BIOMETHANE 3000 module to power on. If it does not turn on at the point power to the system is applied, please wait one minute before pressing any keys on the module.

- 2) If the power on is successful, the 'Landtec BIOMETHANE 3000' logo will appear on screen and then the 'System Self-Test' will commence.



Screen 1 - Power on

**System Start-Up****Language Selection**

When turned on for the first time, the module will ask the user to select the language for the system. See [Set Language](#) for more information.

**Time and Date**

Following selecting the language, if required, the user will need to enter the correct time and date for the local time zone. See [Set Time and Date](#) for more information.

**Interface Board Firmware Update**

Before a self-test commences, the module will check that the firmware version of the Interface Board is to the latest revision. If it is not, the user is asked whether they would like to update their firmware:

Operating Manual

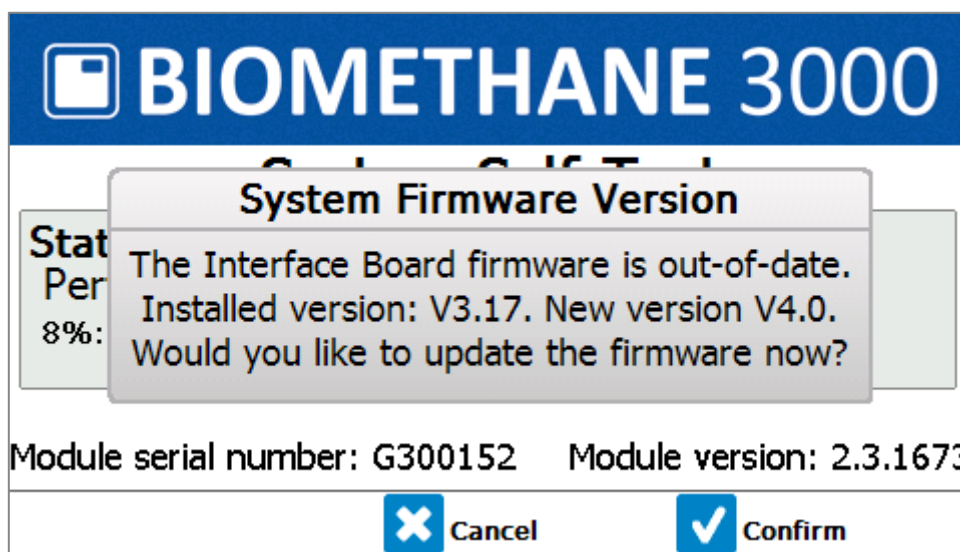

Screen 2 – Interface Board firmware

To update the firmware, press the right soft key ‘Confirm’ to enable the module to program the Interface Board.

**Note:** This could take several minutes depending on the size of the update. During the update, do not turn off the system.

If you do not wish to update the firmware, press the middle soft key to ‘Cancel’. Next time the system or module is restarted, you will be reminded that the firmware version is out of date.

Self-Test

When switched on the module will perform a pre-determined self-test sequence taking approximately sixty seconds. During the self-test, the percentage complete is shown and remains on screen until the self-test is completed.

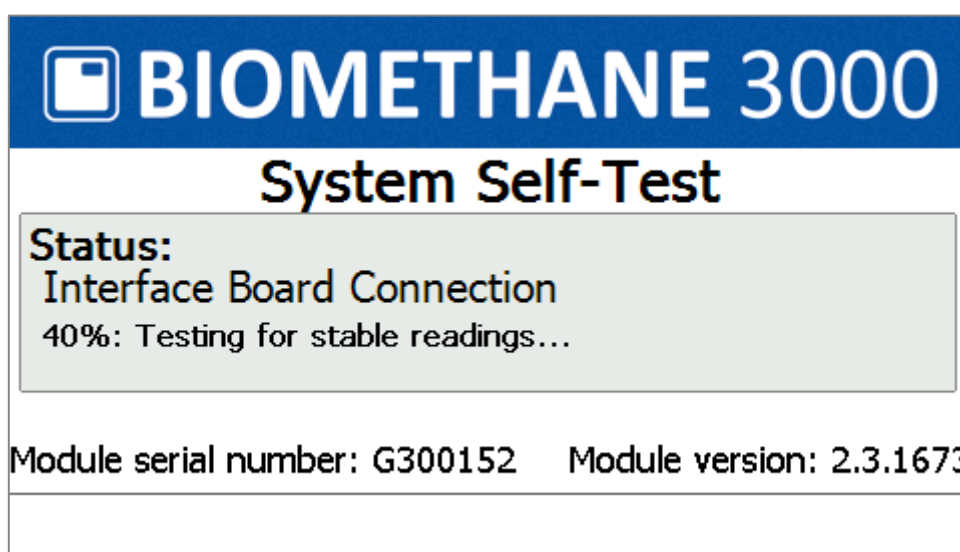

Screen 3 - System Self-Test

## Operating Manual

During this time, many of the system’s functions are tested, including:

- The Interface Board firmware is checked to ensure it is the latest version – see [Interface Board Firmware Update](#).
- Tests that the auto-calibration system has enough bottle pressure to perform a calibration.
- Testing of the CH4, CO2, O2, reference, barometer, internal cell, external cell, and transducers is performed continuously over a short period to check for faults and instability.
- The pump is switched on and the system checked for blockages.
- The next service due date is checked.
- Valid communications to the Interface PCB is checked.
- Test whether the ‘first time configuration’ is required.

If no faults are found, then the first time configuration or monitoring will begin.

Note: After completion, if any non-critical failures occur then [Screen 4 - Self-test finished with warnings](#) screen is shown.

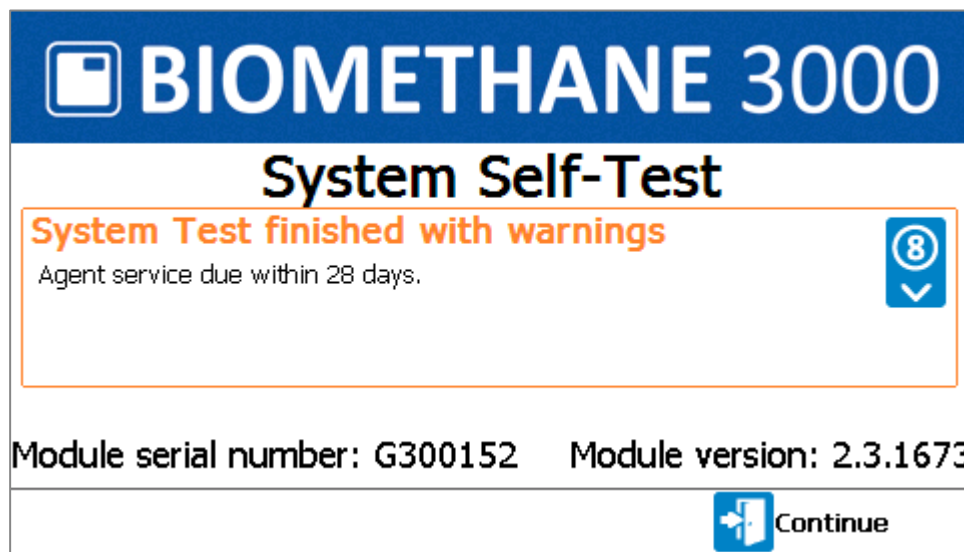

Screen 4 - Self-test finished with warnings

If the fault is ‘service overdue’ or a channel warning (non-critical) then the user can continue to the next stage by pressing the right soft key ‘Continue’. The BIOMETHANE 3000 will continue automatically after thirty seconds if continue is not pressed.

If any critical faults occur, refer to section [Critical Faults](#).

# Operating Manual

Help Function

In some screens, there is a help screen available. An available help screen is indicated by a '?' in the top right hand corner of the screen:

User Calibration
Nitrogen Zero
?

	Target	Current	
CH <sub>4</sub> (%)	0.0	0.0	<input checked="" type="checkbox"/>
CO <sub>2</sub> (%)	0.0	0.0	<input checked="" type="checkbox"/>
O <sub>2</sub> (%)	0.0	-0.0	<input checked="" type="checkbox"/>
H <sub>2</sub> (ppm)	0	900	<input type="checkbox"/>

Check Complete.

All channels are valid.

- 'Set Calibration' to adjust all valid channels.

**Set Calibration**
 **Record**

V2.0.1091

Screen 5 - Help screen available

To access the help screen, press the '?' key on the keypad. The user can scroll through pages using the left and middle soft keys. To exit, press the right soft key.

Note: The 'Gas Readings Screen' also has a help screen but this is not identified on-screen.

## Configure Alarms Help

?

SP

The sample point that will be tested. "All" can be specified to have the alarm condition be enabled on any of the sample points.

Type

">" greater than the specified value. "<" less than the specified value.

Mode

"Normal": When the alarm condition clears the relay is energised immediately.  
 "Latching": When the alarm condition clears, the alarm has to be acknowledged by the user to re-energise the relay.

**Page Down**
 **Page Up**
 **Back**

V2.0.1091

Screen 6 - Help screen example



## Operating Manual

## First Time Configuration

- 1) When switching on the module for the first time the system will detect the first time run conditions and run set-up mode. The BIOMETHANE 3000 is designed to be fully configurable by the end-user without QED support or configuration.

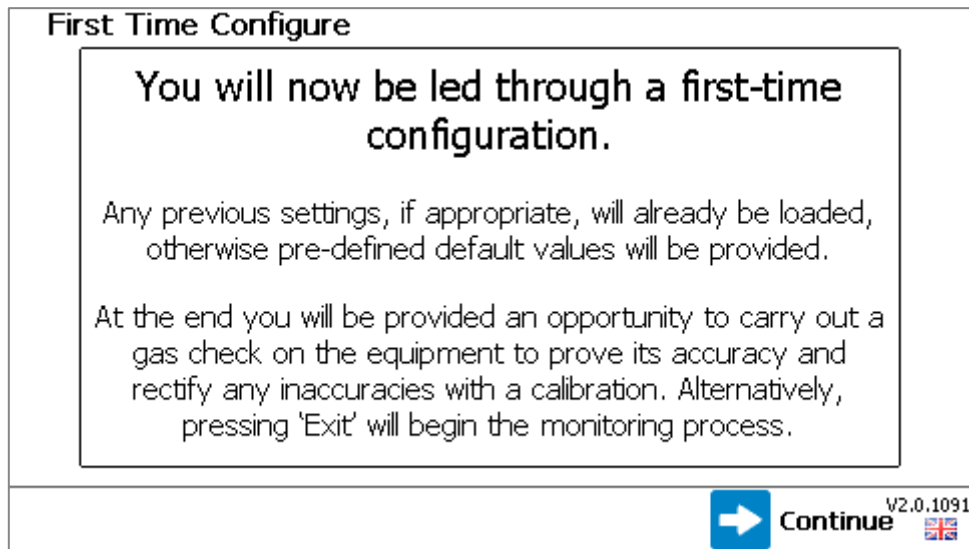

Screen 7 - First time run set-up

- 2) Press the right soft key to 'Continue'.
- 3) Set the time and date for the local time zone. For more information on how to do this, refer to section [Set Time and Date](#).
- 4) Configure the sampling options for the external sensor. For more information on how to do this, refer to section [Sample Times](#).

**Note:** On a BG3KU variant without an external sensor, this option is not present.

- 5) Customize the auto-calibration timings. For more information on how to do this, refer to section [Auto-Calibration Settings](#).
- 6) Customize the relay configuration. For more information on how to do this, refer to section [Configure Relays](#).
- 7) Configure the minimum gas bottle cut-off and warnings for the auto-calibration. For more information on how to do this, refer to section [Auto-Calibration Options](#).
- 8) Configure alarms (if set during the relay configuration option). For more information on how to do this, refer to section [Configure Alarms](#).
- 9) Configure Modbus slave (if being used). For more information on how to do this, refer to section [Configure Modbus Slave](#).
- 10) Configure analog outputs (if being used). For more information on how to do this, refer to section [Configure Analog Outputs](#).



Operating Manual

- 11) Define whether an administrator passcode is required on the system. For more information on how to do this, refer to section [Admin Passcode](#).
- 12) Once the first time run configuration is complete, you will arrive at [Screen 41 - Gas Check](#). To perform this, refer to section [Gas Check and Calibration](#). To skip and begin monitoring, press the right soft key to 'Exit' (not recommended).













Gas Readings Screen

Screen 8 – With an external sensor gas readings and Screen 9 – No external sensor gas readings is considered the normal operating screen and all options are carried out from this starting point:











Screen 8 – With an external sensor gas readings

Screen 9 – No external sensor gas readings

Operating Manual

Reference	Icon	Definition
1	N/A	Displays the time and date and is continuously updated.
2		Sample point number (always '1')
3		Sampling from sample point
		Performing an air purge on the complete system. This would occur after an auto-calibration.
		Idle – waiting for next cycle to begin
		Performing auto-calibration
4		External cell only: Idle – waiting for next cycle to begin
		External cell air purge following sample
		Sampling external cell
5		This is the time remaining for the current operation.
6		This is the time remaining until the auto-calibration commences. Only viewable on models without an external cell but will still occur on system with an external cell.
7		This is the flow rate in ml/min. If this drops below 75ml/min, the reading will have an amber background and the system will flow fail and stop sampling after fifteen seconds – see <a href="#">Low Flow / Flow Fail</a> for more information.
8		Press the left soft key to view the alarm summary screen. The icon will become red with an active alarm. See <a href="#">Alarms</a> section for more information.

Operating Manual

9		Indicates to the user that there is liquid in the catchpot and it needs emptying.
10		Press the middle soft key to stop the sample process and freeze the outputs at their last known value. This can be useful when maintenance on site may be required. See <a href="#">Stop Sampling</a> section.
11		An indication to the user that the module is overdue a service. See <a href="#">Service</a> section.
		An indication to the user that the module is due a service in 28-days. See <a href="#">Service</a> section.
12		This icon displays when there is a non-critical fault present on the system. A non-critical fault is a fault that will not stop the system from functioning. See <a href="#">Fault Detection</a> for more information.
13		Use key '4' to scroll through the previously stored gas readings. This will display the readings in memory for the data being output for the particular sample point shown.
14		Indicates which sample point the data on screen is representing with a number in the eye. These icons are the same as the sample point status icons. An eye without a number represents live readings for the current sample point being monitored.
15		Press the right soft key to view the faults summary screen.
16		Use key '6' to scroll through previously stored gas readings. This will display the readings in memory for the data being output for the particular sample point shown.
17	N/A	Displays the readings for the gases available. Green text indicates the reading is live. Blue text indicates the reading is a stored reading against the sample point. If the gas channel is an external cell, "(ext)" will be shown below the gas name.
18		Displays the current status of the internet server connection, by means of a color-coded symbol, see <a href="#">Table 1</a> .
19		Located above the CH4 reading indicates that the value displayed has been adjusted using the 'Hydrocarbon Adjustment' option. See also <a href="#">Hydrocarbon Adjustment</a>

Operating Manual

Icon	Color	Definition
	Green	Successful connection to the server
	Green / Yellow	Attempting to connect to the server
	Blue	Local connection only, not connected to the server
	Amber	Internet connection problem
	Grey	Idle, connection not attempted

Table 1 - Ethernet connection status

Alarms  
Notification

Note: For information on how to set alarms, please refer to section [Configure Alarms](#).



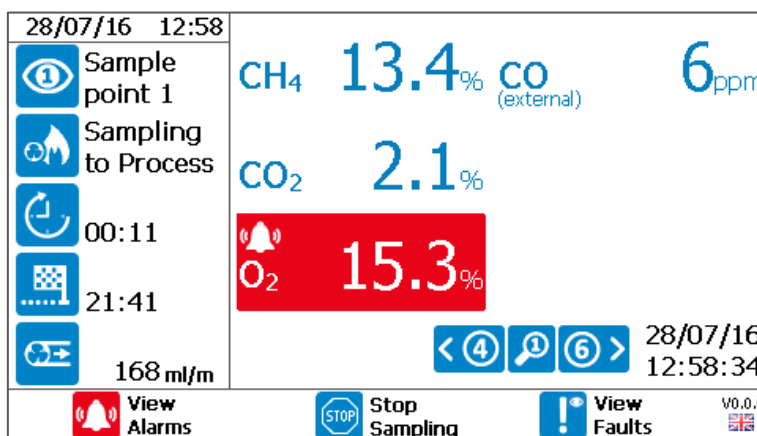

When an alarm condition has been met, the alarming channel will become highlighted with a bell icon and the 'View Alarm' soft key becomes red. An example screen is shown in [Screen 10 - Alarm notification](#).



Screen 10 - Alarm notification

## Operating Manual

The following notifications are available on the BIOMETHANE 3000:

Icon	Definition
	The alarm is active and the associated relay has been de-energized.
	The alarm is active but the channel is within its recovery zone. The associated relay remains de-energized until the recovery value is met.
	This is the latched alarm indicator. This indicates a channel has alarmed and recovered. During this notification, the relay remains de-energized until the alarm notification has been acknowledged by the operator.
	The alarm has been silenced by the operator and the associated relay is energized. The alarm condition on the system remains active in the background until the recovery condition is met.

### Viewing Alarms

To view an alarm, from the 'Gas Readings Screen' press the left soft key to go to [Screen 11 - Alarms summary](#):

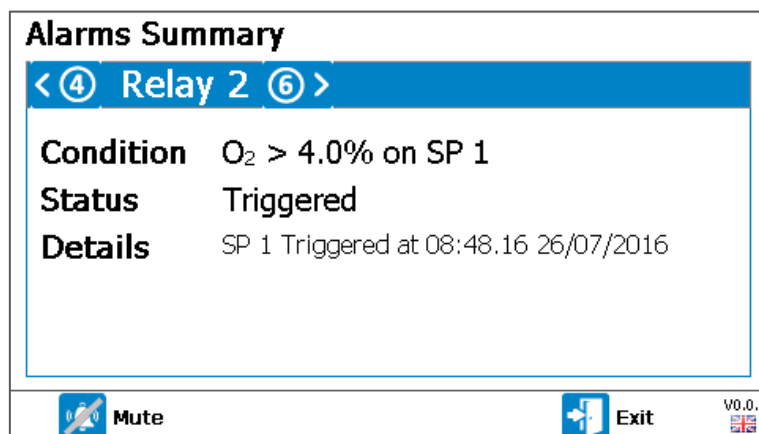

Screen 11 - Alarms summary

This screen will detail all alarm conditions set by the operator. It will detail the condition for the alarm to trigger, the status (inactive, triggered, latched, or recovering), the time and date of the alarm, and the associated relay.

Pressing key '4' and key '6' scrolls the user through the relays available for alarms. This will also summarize inactive alarms.

Pressing the left soft key ('Mute') on an active alarm will disable the alarm and re-energizes the associated relay until the condition is cleared.

Pressing the left soft key ('Clear Latch') on a latched alarm will unlatch the alarm, clearing its status and re-energizes the associated relay.

## Operating Manual

### Stop Sampling

From the 'Gas Readings Screen', pressing the middle soft key will 'Stop Sampling'. At this point, the sampling process is stopped, all solenoid valves are closed, and the outputs are frozen at their last known value. The following screen will be presented to the user:

Output	SP	Gas	Reading	mA
1	1	CO2	0.0	4.0
2	All	O2	5.5	7.5
3		(Disabled)		
4		(Disabled)		
5		(Disabled)		
6		(Disabled)		

Screen 12 - Sampling Stopped

Pressing the left soft key will 'Restart' the sampling process and return the user to the 'Gas Readings Screen'.

**Note:** When resuming the sampling process, all active alarms will become inactive until retriggered as part of the process.

Pressing the middle soft key will fix the outputs to the pre-determined safe values. These are shown in the table onscreen.

Pressing the right soft key allows the user to edit the safe values. For more information on this, please see [Configure Analog Outputs](#).

### Menu

The menu enables the operator to select options to set-up specific parameters and perform operational tasks.

The menu is divided in to three areas:

- 1) Settings – this menu appears from the 'Gas Readings Screen' when pressing the 'Menu' key
- 2) Calibration – this menu is accessed from either the 'Settings' menu or the 'Device Info' menu by pressing the middle soft key
- 3) Device Info – the device information menu is accessed from either the 'Settings' menu by pressing the left soft key.

## Operating Manual

### Settings Menu

Depending on the option chosen at manufacture, the following options are available from the settings menu:

- 1) Sample Times

Note: On a BG3KU with an external cell, this option will be for the external cell sample options as the rest of the system runs continuously.

Note: On a BG3KU without an external cell, this option will be the 'Auto-Calibration'.

- 2) Configure Alarms
- 3) Configure Interface
- 4) Adjust Backlight
- 5) Set Time and Date
- 6) Admin Passcode
- 7) Auto-Calibration

Note: This option is only present on BG3KU variants with an external cell. On BG3KU variants without an external cell, this option will not be present.

- 8) Set Language

An example of the 'Settings' menu is shown in [Screen 13 - Settings Menu](#).

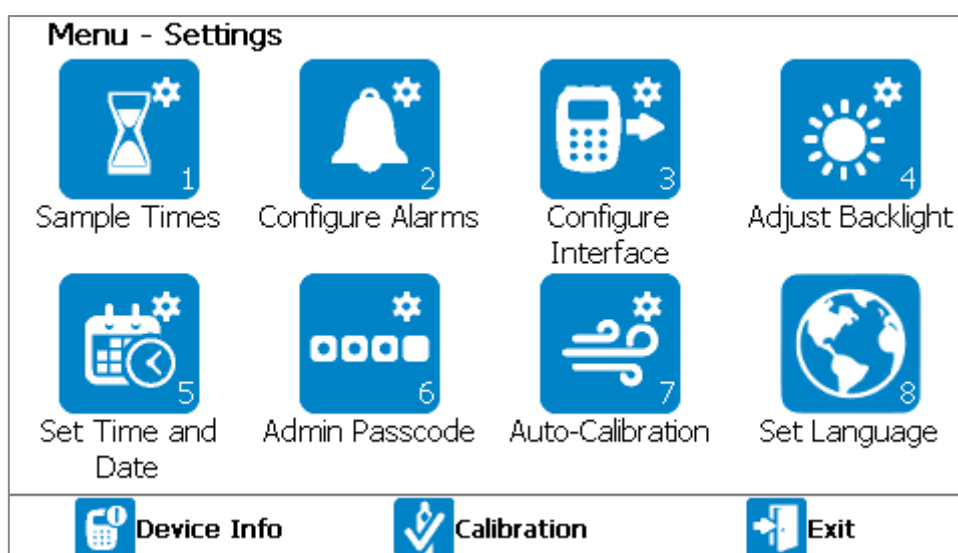

Screen 13 - Settings Menu

Following a change to 'Sample Times', 'Configure Interface', 'Set Time and Date', or 'Auto-Calibration', when returning to the 'Gas Readings Screen', the system will apply the new configuration once

## Operating Manual

'Confirm' is pressed using the left soft key.

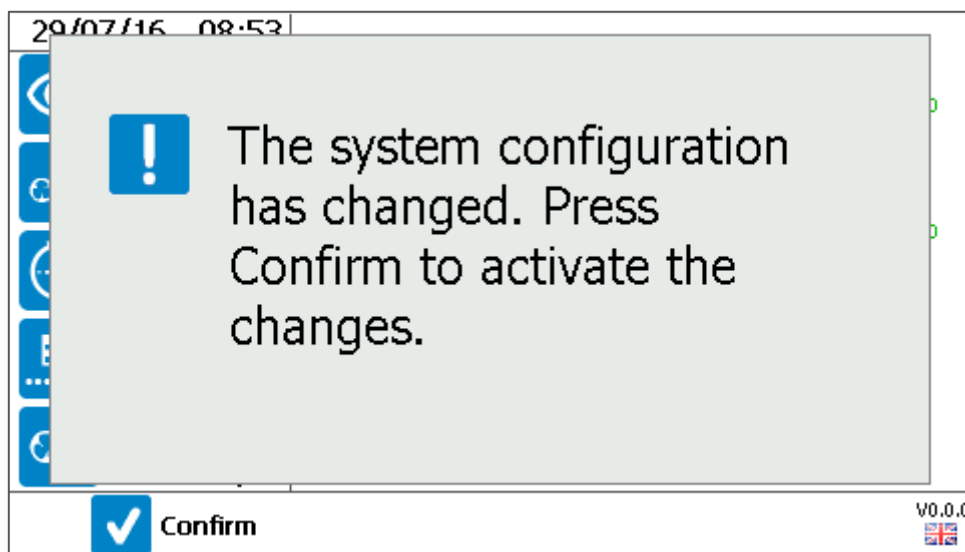

Screen 14 - Confirm new configuration

### Sample Times

This option allows the operator to define the duration of the external sensor (if the system is equipped with this option).

- 1) From the 'Settings' menu press key '1' to select the 'Sample Times' option. A summary screen will be shown.

Configure Sample Times		
SP	Duration	Air Purge
External Cell	01:30	00:03:00
Total	00:04:30	
Sample	00:30:00	

v0.0.1

Screen 15 - Configure Sample Times

- 2) Press the right soft key to 'Exit' without saving any changes.
- 3) To edit a parameter, press the middle soft key to enter 'Edit' mode.
- 4) Using the scroll keys, select a parameter to edit (highlighted in the table) and select the field with the ↵ key.



## Operating Manual

Note: In addition to the external cell timings being editable, the 'Cycle' time is also an editable parameter. This is the total time of the cycle before the external cell is monitored again.

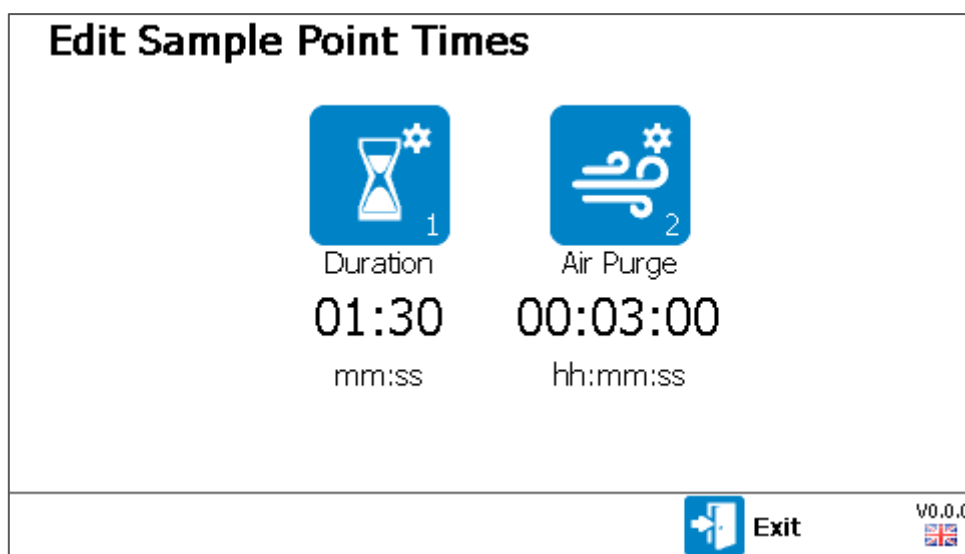

Screen 16 - Edit Sample Point Times

- 5) Press key '1' to edit the sample duration or key '2' to edit the air purge duration.
- 6) Key in a suitable time for the system and store using the ↵ key.

Note: Both parameters have minimum and maximum values that can be entered. If a time is outside of this range, the user will be prompted to enter a more suitable time.

- 7) Once a parameter has been changed, the left soft key becomes available to 'Save and Exit'. Once pressed, the user will be returned to the summary screen.

Note: If changing a duration exceeds the 'Cycle' time, the 'Cycle' time will automatically be updated to accommodate the change.

- 8) Press the right soft key to 'Exit' back to the 'Settings' menu.

### Configure Alarms

This option allows the operator to define alarm conditions for a gas on the measured sample point and a low-pressure alarm for the auto-calibration gas bottle.



The relays operate in fail-safe mode. This means the relay is normally energized. When an alarm condition is met, the relay de-energizes.

Note: The quantity of available alarms will be dependent on the relay configuration, see [Configure Relays](#) section. The relay configuration should be determined before configuring the alarms.

- 1) From the 'Settings' menu press key '2' to select the 'Configure Alarms' option.

Operating Manual

Configure Alarms						
Relay	Channel	SP	Type	Mode	Value	Recovery
1	CH4	1	>	Normal	60.0	50.0
2	O2	1	>	Normal	4.0	0.0
3		1	Disabled	Normal	0.0	0.0
4		1	Disabled	Normal	0.0	0.0
6		1	Disabled	Normal	0.0	0.0

 **Edit**
 **Exit**
v0.0.1  

Screen 17 - Configure Alarms

- 2) Press the right soft key to 'Exit' without saving any changes.
- 3) To 'Edit' a parameter, press the middle soft key to enter edit mode. Using the scroll keys, select a parameter to edit (highlighted in the table) and select the field with the ← key.

Definitions

Term	Definition
Relay	Indicates the relay that will be assigned to the alarm.
Channel	Indicates the channel being monitored for the alarm condition.
SP	The sample point (1) for which the alarm condition is to be monitored.
>	Alarm to trigger above the value.
<	Alarm to trigger below the value.
Disabled	Alarm is disabled and will not activate.
Normal	When an alarm has occurred and the gas concentration reaches its recovery value, the alarm will deactivate.
Latched	When an alarm has occurred and the gas concentration reaches its recovery value, the alarm will remain activate until cleared by the operator.
Value	The gas concentration for which the alarm condition will become active.
Recovery	The gas concentration for which the alarm condition will recover.

- 4) Use the scroll keys to select the chosen parameter and select using the ← key, or use the keypad to enter the gas concentration for the value followed by the ← key to confirm.
- 5) Once a parameter has been changed, the left soft key becomes available to 'Save and Exit'. Once pressed, the user will be returned to the 'Settings' menu.

**Note:** Alarm settings become active immediately.

**Note:** When any alarm setting is updated all active alarms will reset.

## Operating Manual

### Configure Interface

This option allows the operator to configure the various interface options with the system to the client’s side. There are three options in this sub-menu:

- 1) Configure Analog Outputs
- 2) Configure Modbus Slave
- 3) Configure Relays
- 4) Configure Pump
- 5) Auto-Calibration Options

To ‘Exit’ this screen, press the right soft key to return to the ‘Settings’ menu.



#### Configure Analog Outputs

This option allows the user to configure the six 4-20mA analog outputs. The user can define a gas channel or the auto-calibration input pressure (ACIP) and set the safe-value that is output should the customer select this option via the [Stop Sampling](#) feature.

**Note:** The safe value is a set value that will force the 4-20mA and Modbus registers to pre-fixed values. This is to prevent erroneous errors or alarm conditions in the user’s remote system whilst maintenance is being performed on the BIOMETHANE 3000 or any other plant equipment.

- 1) From the ‘Configure Interface’ menu press key ‘1’ to select the ‘Configure Analog Outputs’ option.

<b>Configure Analogue Outputs</b> 				
Output	Sample Point	Gas	Safe Value	mA
1	1	CH4	55.0	12.8
2	1	CO2	40.0	10.4
3	1	O2	0.0	0.0
4	Disabled		0.0	0.0
5	Disabled		0.0	0.0
6	Disabled		0.0	0.0

 Edit
 Exit
V0.0.1 

Screen 18 - Configure Analog Outputs

- 2) Press the right soft key to ‘Exit’ without saving any changes.

## Operating Manual

Note: If the user has accessed the 'Configure Analog Outputs' screen via the 'Stop Sampling' screen, the user will be returned to the 'Stop Sampling' screen.

- 3) To 'Edit' a parameter, press the middle soft key to enter edit mode. Using the scroll keys, select a parameter to edit (highlighted in the table) and select the field with the ↵ key.
- 4) Use the scroll keys to select the chosen parameter and select using the ↵ key, or use the keypad to enter the gas concentration for the safe value followed by the ↵ key to confirm.
- 5) Once a parameter has been changed, the left soft key becomes available to 'Save and Exit'. Once pressed, the user will be returned to the 'Configure Interface' menu.

### Configure Modbus Slave

This option allows the user to configure the Modbus digital output of the BIOMETHANE 3000. The user can change the following parameters:

- Slave Address – this is the address of the BIOMETHANE 3000 on the bus.
  - Baud Rate – Information is transferred in a communication channel at this rate. Modbus is typically 9600 or 19200.
  - Data Bits – the number of bits used to represent one character of data. This parameter cannot be changed.
  - Parity – the parity bit is used as a simple error detection algorithm. Setting parity to odd will result in an odd number of 1 bits.
  - Stop Bits – this is the number of bits to identify the end of a byte. This is typically set to 1.
  - Termination – this is used to enable/disable the termination resistor within the system. This is typically enabled for systems that are the first or last connection on the bus.
- 1) From the 'Configure Interface' menu press key '2' to select the 'Configure Modbus Slave' option.

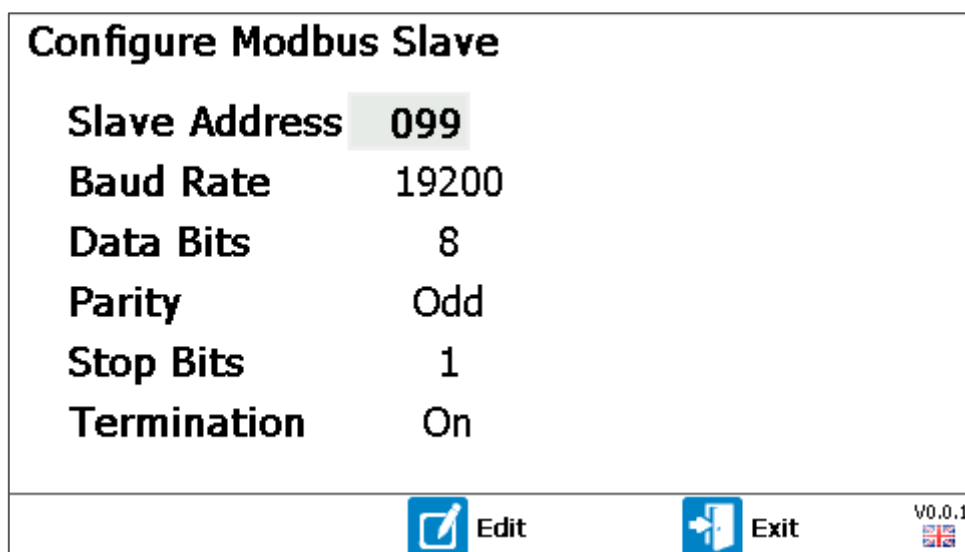

Screen 19 - Configure Modbus Slave

## Operating Manual

- 2) Press the right soft key to 'Exit' without saving any changes.
- 3) To 'Edit' a parameter, press the middle soft key to enter edit mode. Using the scroll keys, select a parameter to edit (option will be highlighted) and select the field with the ↵ key.
- 4) Use the scroll keys to select the chosen parameter and select using the ↵ key, or use the keypad to enter the numeric required followed by the ↵ key to confirm.
- 5) Once a parameter has been changed, the left soft key becomes available to 'Save and Exit'. Once pressed, the user will be returned to the 'Configure Interface' menu.

### Configure Relays

This option allows the user to configure the eight relays in the system. 'Relay 8' is the fault relay and cannot be changed.

- 1) From the 'Configure Interface' menu press key '3' to select the 'Configure Relays' option.

Effective configuration	
Relay 1	Alarms (free)
Relay 2	Alarms (free)
Relay 3	Alarms (free)
Relay 4	Alarms (free)
Relay 5	Air In
Relay 6	Alarms (free)
Relay 7	Alarms (free)
Relay 8	Fault

Screen 20 - Configure Relays

- 2) Press the right soft key to 'Exit' without saving any changes.
- 3) Press key '1' to change the 'Mode' of the relays. Available options are:
  - Alarms only – Relays are only used to indicate an alarm status (refer to [Configure Alarms](#) for information on how to define alarm settings)
  - Indicate 4-20mA outputs sample point – This mode enables a relay for when the 4-20mA signal is valid for a given sample point.

Operating Manual

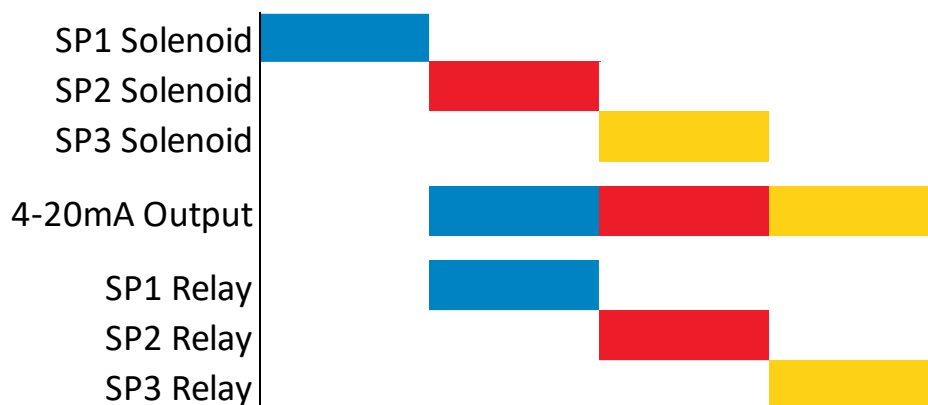

Figure 14 - 4-20mA notification

- Indicates current sample point solenoid – This mode enables a relay for when a sample point is being monitored.

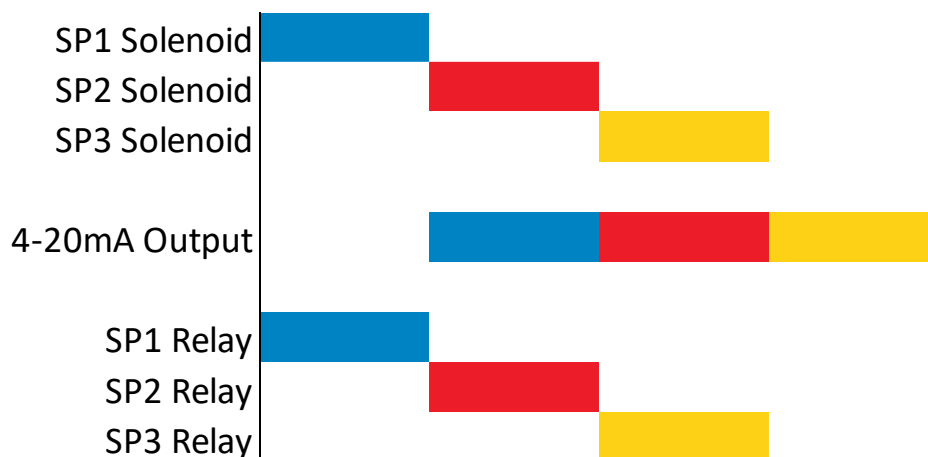

Figure 15 - Sample point notification

Note: When enabling the relays for 4-20mA or sample point notification, the remaining available relays will automatically be defaulted to 'Alarms'.

- 4) Press key '2' to define whether a relay is used to indicate when an air purge is occurring. If this option is selected, this will automatically be defaulted to 'Relay 5'.
- 5) Press key '3' to define whether a relay is used to indicate when the catchpot contains liquid and needs emptying. If this option is selected, this will automatically be defaulted to 'Relay 7'.

Note: If the system was fitted with the auto-drain option at point of manufacture, this option will not be available in the 'Configure Relays' screen.

- 6) Press key '4' to define whether a relay is used to indicate whether an auto-calibration was successful. If this is selected, this will automatically be defaulted to 'Relay 6'.
- 7) Once a parameter has been changed, the left soft key becomes available to 'Save and Exit'. Once pressed, the user will be returned to the 'Configure Interface' menu.

## Operating Manual

### Configure Ethernet

This option allows the user to configure the Internet Connectivity, to enables the user to access the system remotely using an online cloud-based portal. The benefits of this include remote access to:

- View live gas readings and sensor readings
- View live system status
- Perform air calibration
- Stop and restart the sampling process
- Restart the system
- View system settings
- View event log data
- Update the firmware
- Requesting remote technical support

**Note: A network firewall exception for port 6470 will be required to allow authorized access.**

The user can change the following parameters:

- Auto-DHCP
- Auto-connection
- IP address
- Subnet mask
- Gateway
- DNS Server

Operating Manual

- 1) From the 'Configure Interface' menu press key " " to select the 'Configure Ethernet' option.

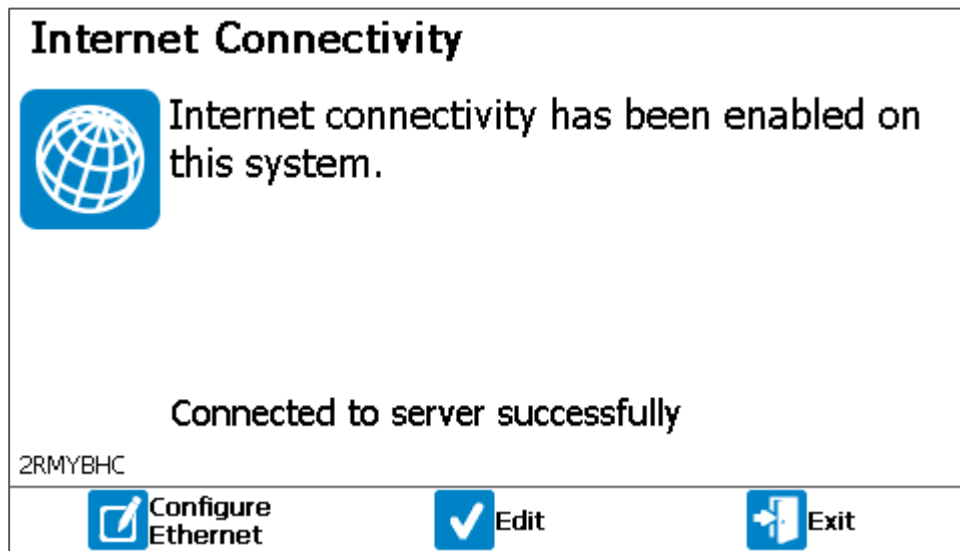

Screen 21 – Configure Ethernet, Internet Connectivity

- 2) Pressing the right soft key exits to the 'Configure Interface' screen, and pressing the left soft key 'Configure Ethernet' allows the user to manually change settings. Press the middle soft key option 'Edit' to enable Internet Connectivity.

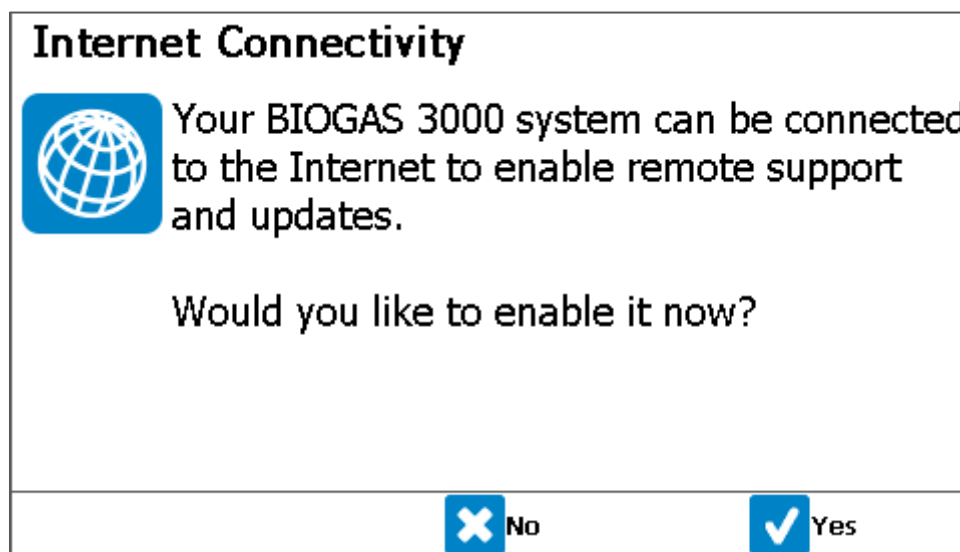

Screen 22- Configure Ethernet, enable connection

- 3) Press middle soft key 'No' to return to the Configure Interface screen, or press right soft key 'Yes' to enable internet connectivity.



Operating Manual

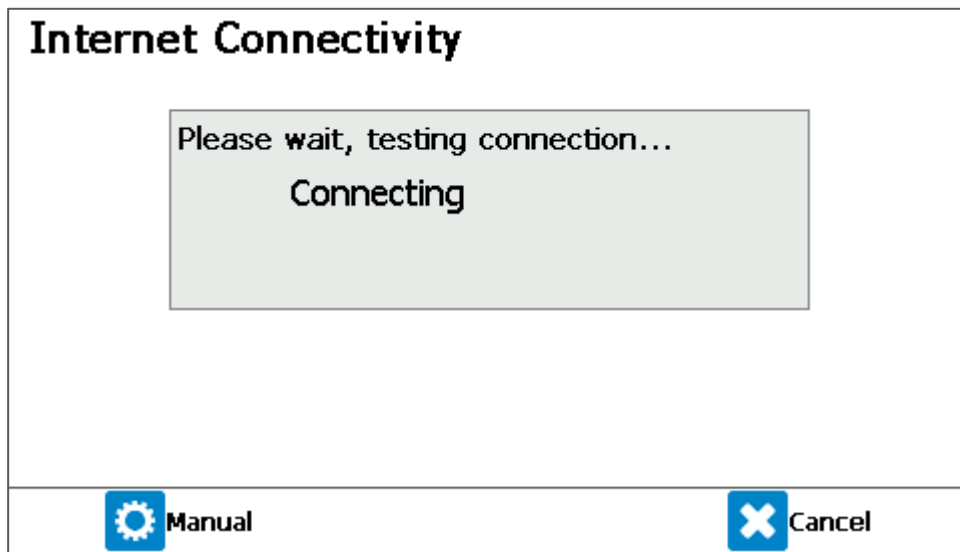

Screen 23 - Configure Ethernet, connection test

- 4) The system will now attempt to connect to the server. This test should take less than 1 minute.

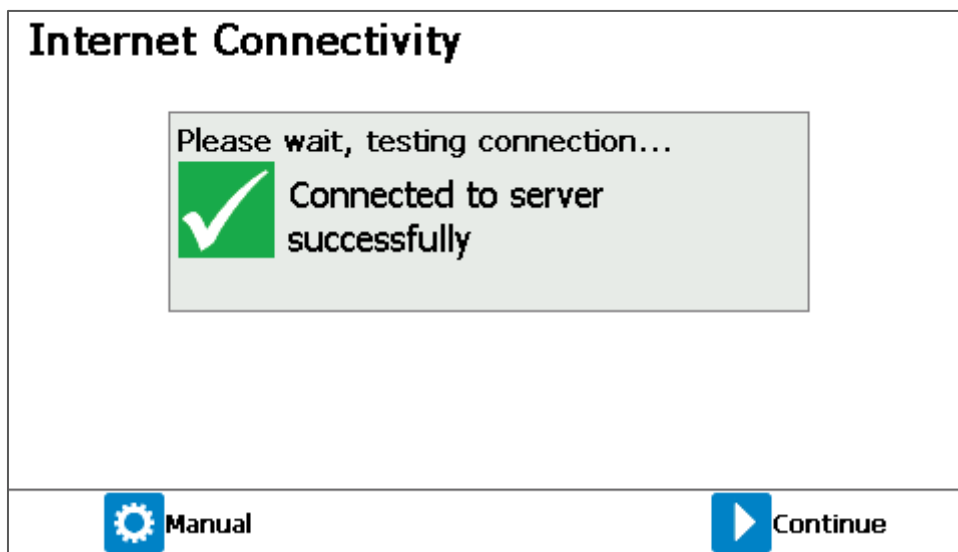

Screen 24 - Configure Ethernet, connected successfully

- 5) A message will indicate the status of the connection. If unsuccessful, use the left soft key to manually edit the Ethernet settings, or the right soft key to return to the 'Configure Interface' menu. If successful, press the right soft key option 'Continue' to proceed to the security code screen.

Operating Manual

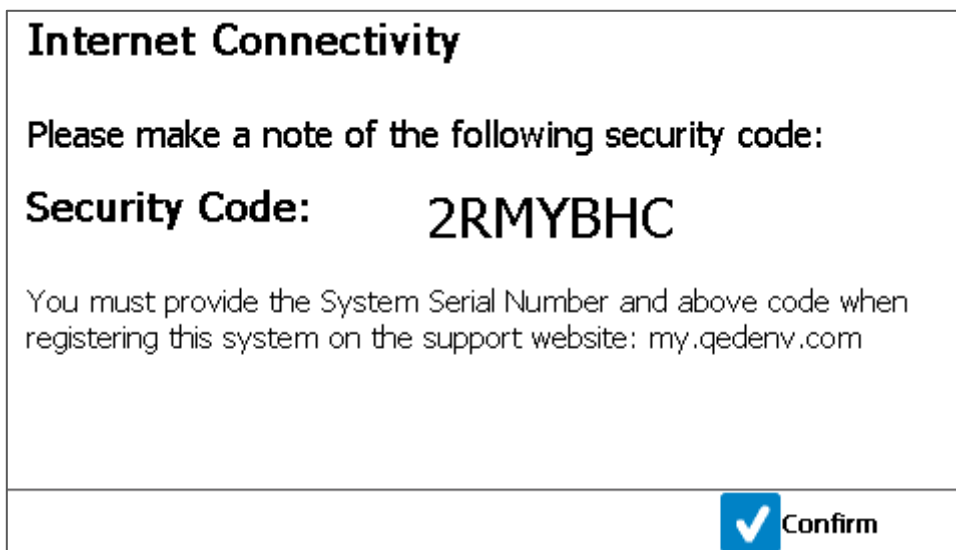

Screen 25 - Configure Ethernet, Security Code

- 6) The displayed 'Security Code' is unique to your system. Use this code together with your system serial number (e.g. BG3K1234) to register your system on the 'QED Customer Portal' at <https://my.qedenv.com> to gain the benefits of Internet connectivity.

This security code is also displayed in the bottom left of on the Internet Connectivity [Screen 21](#).

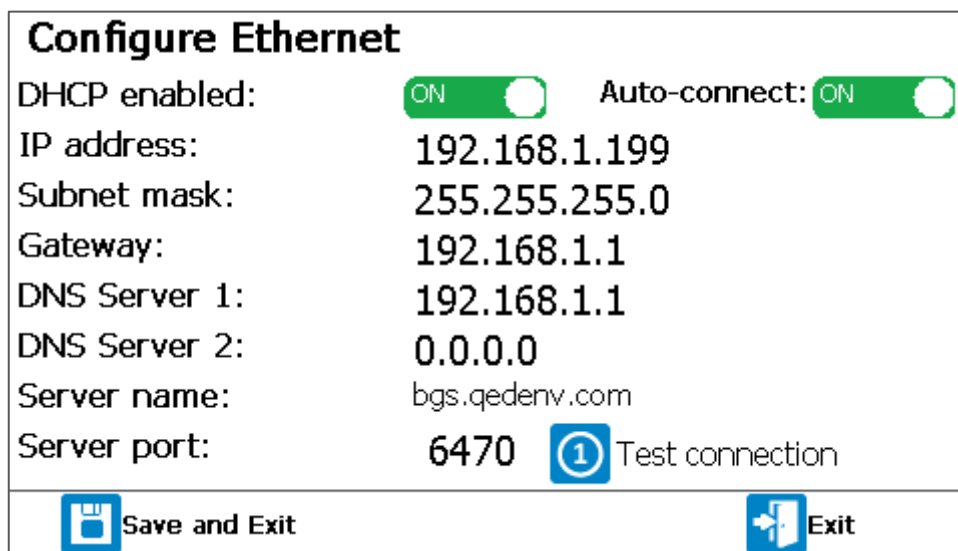

Screen 26 – Configure Ethernet, manual configuration

- 7) Manually configure the Ethernet settings by pressing the left soft key 'Configure Ethernet' on the main 'Internet Connectivity' screen or left soft key 'Manual' after a failed connection attempt.
- 8) Press middle soft key 'Edit'. Toggle the 'DHCP enabled' and 'Auto-connect' options using the enter '↵' key. Use the arrow keys to navigate to the other options and press enter '↵' to edit.

## Operating Manual

Use the number keys to enter new addresses and enter '←' to save. Use the middle soft key 'Delete' to backspace, or press right soft key 'Cancel' during editing to discard any changes made to that field.

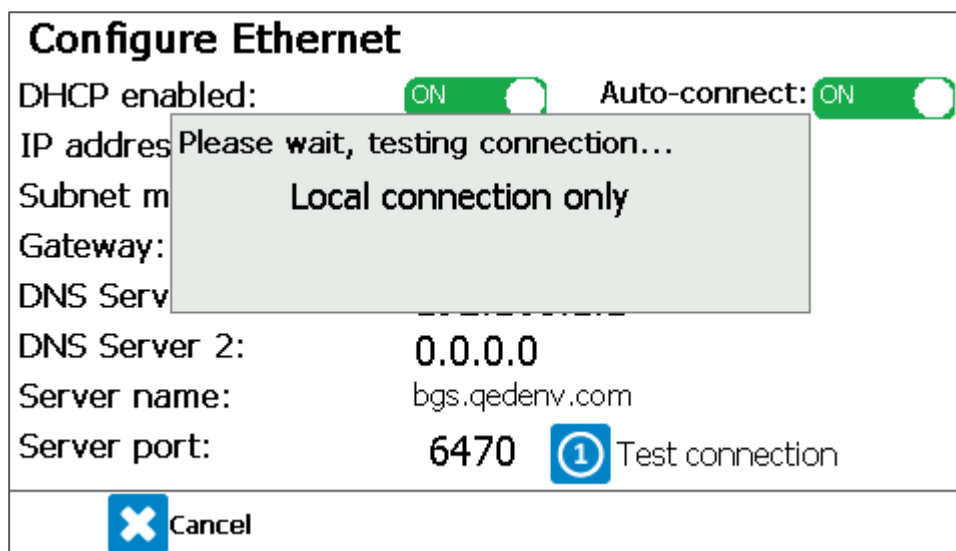

Screen 27 - Configure Ethernet, manual connection test

- 9) Press key '1' to 'Test connection' settings. Use left soft key 'Cancel' to exit a failed attempt.
- 10) Press left soft key 'Save and Exit' to save changes and reattempt internet connection.
- 11) An icon in the top right of the main gas reading screen indicates internet connection status, see also [Gas Readings Screen](#).

### Configure Pump

This option allows the user to configure the control of the pump within the system. The default setting at point of manufacture is off ('natural flow') as most sites will have a positive pressure sufficient for the monitoring of the sample.

**Note:** The pump will still operate when the system is performing an air purge as part of the auto-calibration or as part of user calibrations.

- 1) From the 'Configure Interface' menu press key '4' to select the 'Configure Pump' option.

## Operating Manual

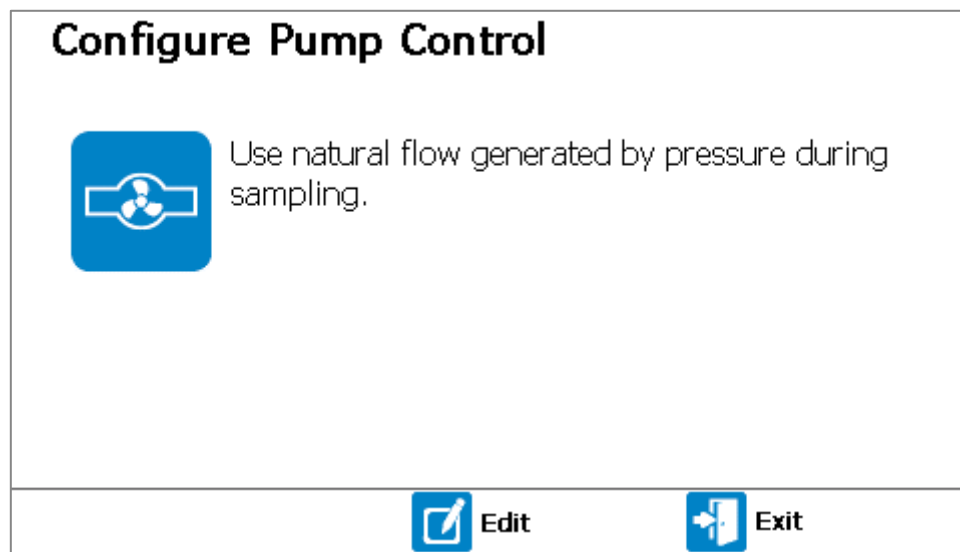

Screen 28 – Configure pump control

- 2) Press the right soft key to 'Exit' without saving any changes.
- 3) Press the middle soft key to enable 'Edit' mode
- 4) Press key '1' to toggle the configuration of the pump. Options are:
  - Use the pump to force the flow during sampling
  - Use natural flow generated by pressure during sampling (default setting)
- 5) Once a parameter has been changed, the left soft key becomes available to 'Save and Exit'. Once pressed, the user will be returned to the 'Configure Interface' menu.

#### Auto-Calibration Options

This option allows the user to specify the warning pressure that notifies the user the gas bottle is running low and the minimum bottle pressure permitted to perform a calibration.

- 1) From the 'Configure Interface' menu press key '5' to select the 'Auto-Calibration Options'.

## Operating Manual

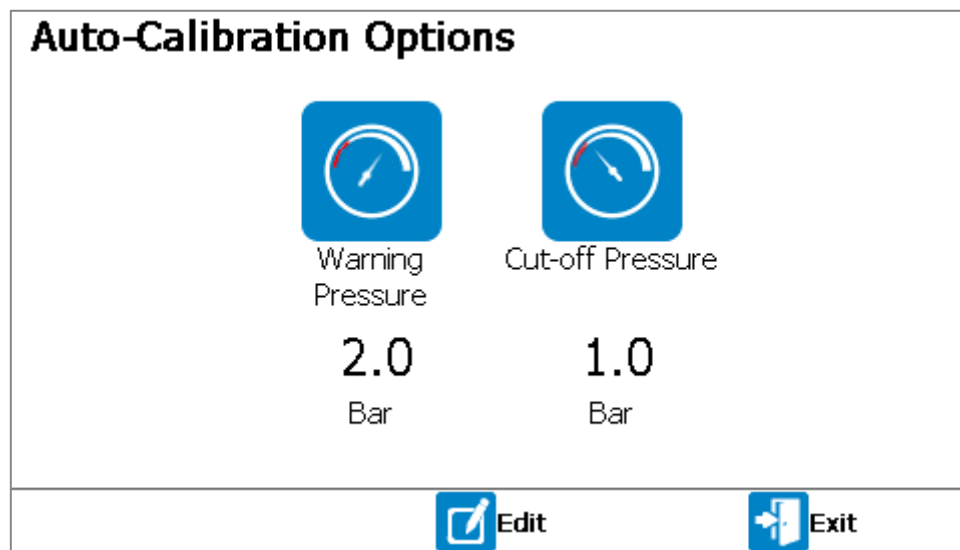

Screen 29 – Auto-Calibration options

- 2) Press the right soft key to 'Exit' without saving any changes.
- 3) Press the middle soft key to enable 'Edit' mode
- 4) Press key '1' to edit the 'Warning Pressure' or key '2' to edit the 'Cut-off Pressure'
- 5) Use the keypad to enter the bottle pressure in Bar followed by the ↵ key to confirm.
- 6) Once a parameter has been changed, the left soft key becomes available to 'Save and Exit'. Once pressed, the user will be returned to the 'Configure Interface' menu.

### Adjust Backlight

This option allows the operator to set the brightness of the backlight and the timer for when it will auto-dim. In addition, the backlight can also be controlled using the 'backlight' key at any time. Having a brighter backlight will improve the readability of the display in bright sunlight.

- 1) From the 'Settings' menu press key '4' to select the 'Adjust Backlight' option.

## Operating Manual

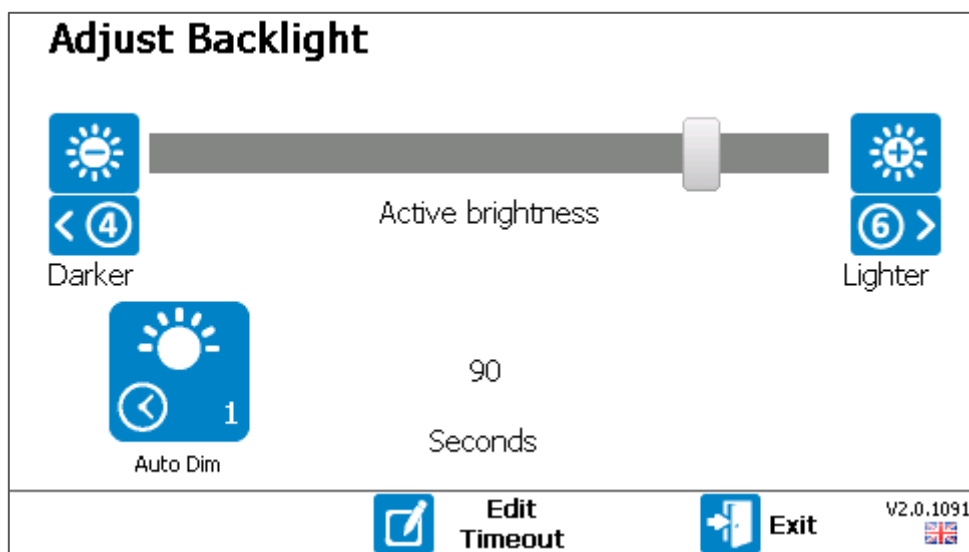

Screen 30 - Adjust Backlight

- 2) Press the right soft key to 'Exit' without saving any changes.
- 3) Press key '6' to increase the brightness of the display or use key '4' to reduce the brightness.
- 4) Press key '1' to set whether the backlight auto-dims after a timeout or is always on and controlled manually by the 'Backlight' key.
- 5) If 'Auto Dim' is enabled, press the middle soft key to edit the auto-dim timeout. Use the keypad to enter a value and store using the ↵ key.
- 6) Once the settings have been changed, the left soft key becomes available to 'Save and Exit'. Once pressed, the user will be returned to the 'Configure Interface' menu.

### Set Time and Date

This option allows the user to set the time and date on the system. The time and date is recorded alongside the reading taken for each sample point.

- 1) From the 'Settings' menu press key '5' to select the 'Set Time and Date' option.

## Operating Manual

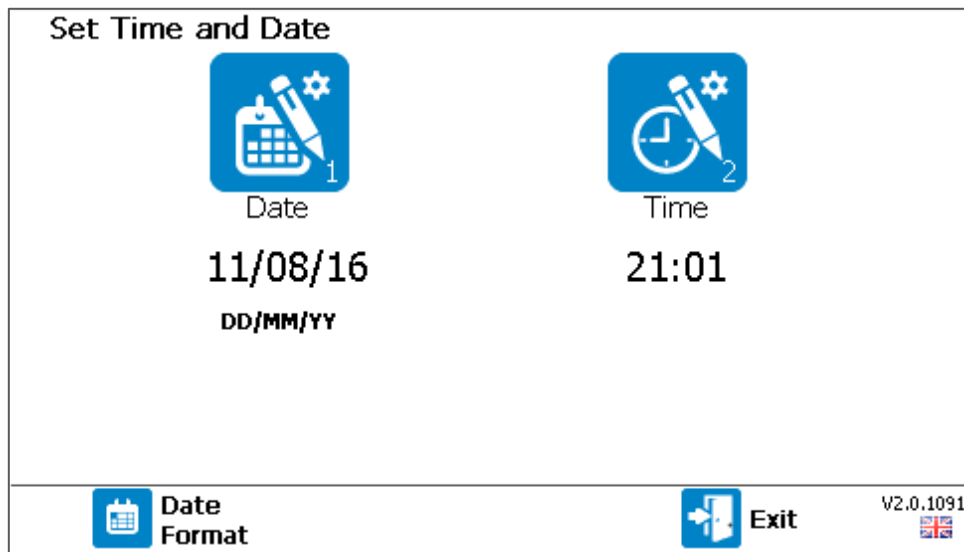

Screen 31 - Set Time and Date

- 2) Press the right soft key to 'Exit' without saving any changes.
- 3) Press the left soft key to toggle the date format. Available options are DD/MM/YY, MM/DD/YY, and YY/MM/DD.
- 4) Press key '1' to edit the date or key '2' to edit the time.
- 5) Key in a suitable date or time for the system and store using the ↵ key.

**Note: Invalid time or date entries will not be accepted.**

- 6) Once the setting has been changed, it is stored immediately.

**Note: At this point, the new setting is written to the Interface PCB. If this is not successful, an error message is displayed and the setting will need to be entered again.**

- 7) Press the right soft key to 'Exit'. Once pressed, the user will be returned to the 'Settings' menu.

### Admin Passcode

The administrator passcode protects against unauthorized changes to the system's set-up. The following screens are passcode protected:

- Sample Times
- Configure Alarms
- Configure Analog Outputs
- Configure Modbus Slave
- Configure Relays
- Configure Ethernet

## Operating Manual

- Admin Passcode
- Auto-calibration Settings
- Calibration menu

1) From the 'Settings' menu press key '6' to select the 'Admin Passcode' option.

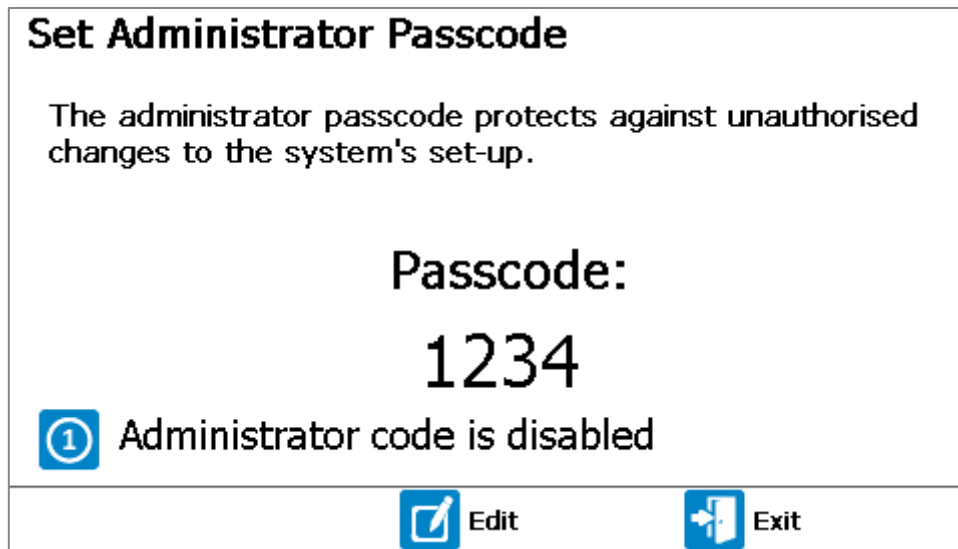

Screen 32 - Set Administrator Passcode

- 2) Press the right soft key to 'Exit' without saving any changes.
- 3) Press key '1' to enable or disable the administrator passcode.
- 4) To 'Edit' the current passcode, press the middle soft key to enter edit mode. Using the keypad, enter a four-digit passcode and press the ↵ key to commit the passcode.
- 5) Once committed, the right soft key becomes available to 'Save and Exit'. Once pressed, the user will be returned to the 'Settings' menu.
- 6) Alternatively, the operator can press the left soft key to 'Cancel' their changes. This option will also return the user to the 'Settings' menu.

#### Administrator Passcode Required Prompt

When trying to edit a parameter that is passcode protected, the user will be prompted with [Screen 33 - Administrator Passcode Required prompt](#).



Operating Manual

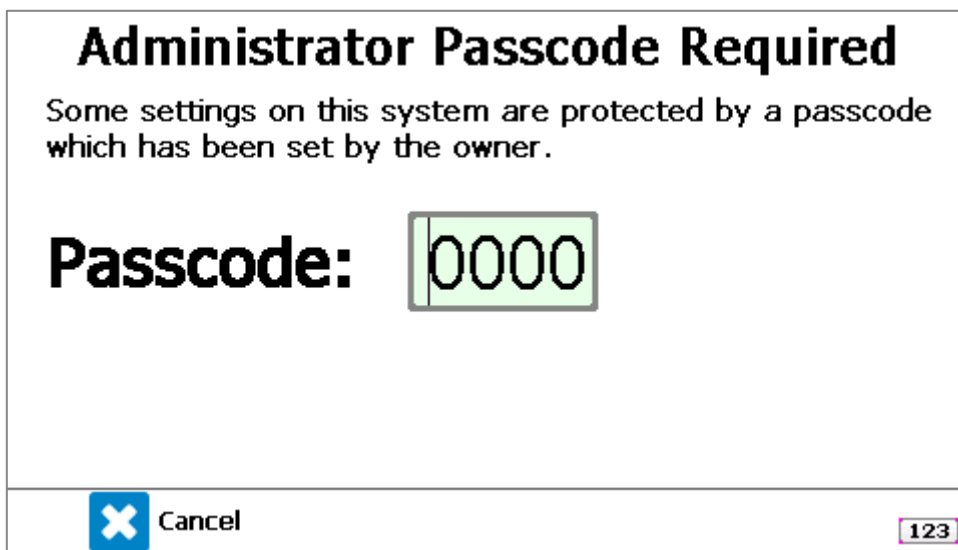

Screen 33 - Administrator Passcode Required prompt

For the user to edit the setting, they must enter the correct passcode followed by the ↵ key. Once the passcode has been entered once, it will not need to be entered while remaining in the menu.

Once the user has returned to the 'Gas Readings Screen', any further changes to the passcode-protected settings will require the administrator passcode to be entered again.

Auto-Calibration Settings

This screen allows the operator to define the settings for the auto-calibration of the BIOMETHANE 3000.

- 1) From the 'Settings' menu press key '7' to select the 'Daily Air Purge' option.



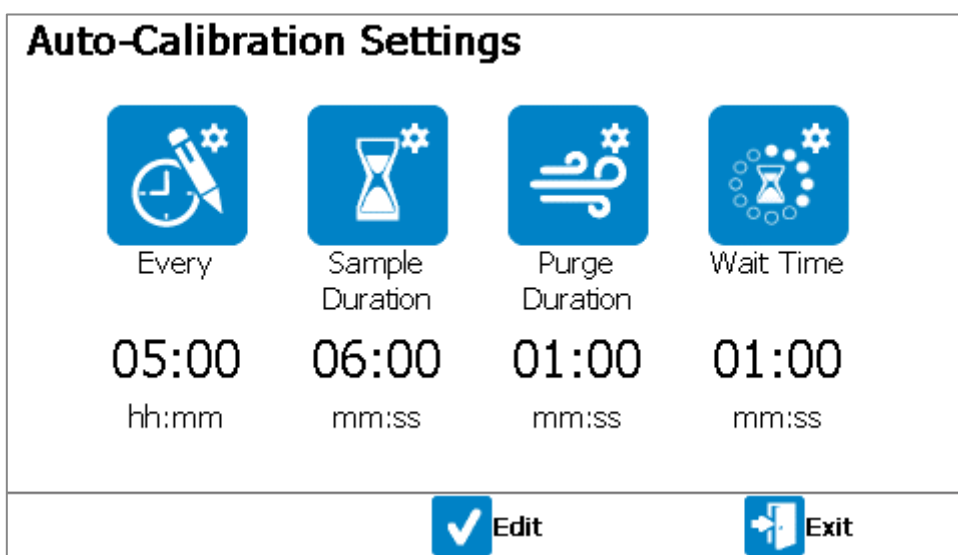

Note: For a BG3KU without an external sensor, the daily air purge will be option '1' in the 'Settings' menu.



Screen 34 – Auto-Calibration Settings

## Operating Manual

- 2) Press the right soft key to 'Exit' without saving any changes.
- 3) Press the middle soft key to enable 'Edit' mode.
- 4) Press key '1' to edit 'Every', key '2' to edit the 'Sample Duration', key '3' to edit the 'Purge Duration', or key '4' to edit the 'Wait Time'.

Term	Definition
 'Every'	Interval between auto-calibrations, from process start time to process start time. This timer is reset when the sampling process is stopped and restarted (e.g. because of a configuration change).
 'Sample Duration'	Period of time for which the calibration gas is purged through the system to obtain a stable reading in preparation for a calibration.
 'Purge Duration'	Period of time for which air is purged through the system to clear the calibration gas in preparation for resuming sampling.
 'Wait Time'	Period of time for which the system does not store or output any new readings whilst the sample gas reading is allowed to stabilize.

Note: If the local environment is susceptible to frequent and/or fast changes in temperature and/or pressure, it is recommended that a more frequent auto-calibration be performed to maintain the accuracy required.

Note: The 'Wait Time' is the time the system waits before updating the outputs when sampling is recommenced after a daily air purge, gas check, calibration, or stopping the sampling process. It is important that a suitable time be entered to ensure the system readings have stabilized to avoid false alarms.

Note: All parameters have minimum and maximum values that can be entered. If a time is outside of this range, the user will be prompted to enter a more suitable time.

- 5) Key in a suitable time for the system and store using the ↵ key.
- 6) Once a parameter has been changed, the left soft key becomes available to 'Save and Exit'. Once pressed, the user will be returned to the 'Settings' menu.

### Set Language

This screen allows the operator to define the language setting for the module. Currently, there are seven supported languages; English, Spanish, German, French, Italian, Polish and Chinese.

- 1) From the 'Settings' menu press key '8' to select the 'Set Language' option.

## Operating Manual

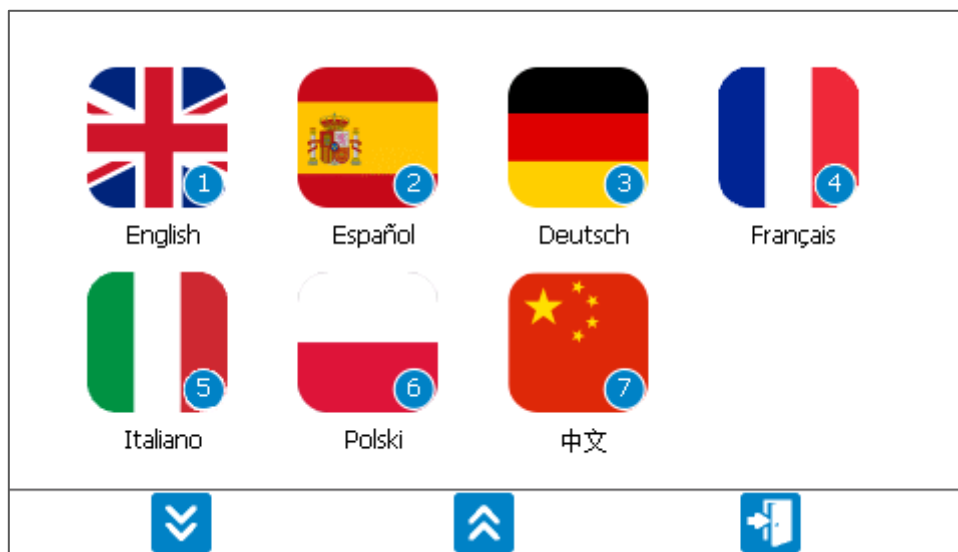

Screen 35 – Set Language

- 2) Press the right soft key to 'Exit' without saving any changes.
- 3) Press the number on the flag for the language you would like to select.

**Note:** Once selected, a prompt in the selected language will pop-up advising the user to 'please wait'.

- 4) Once the language is applied, the user will be returned to the 'Settings Menu'.

#### Device Information Menu

The device information menu contains information relating to the system. The following options are available from the 'Device Info' menu:

- 1) System Information
- 2) Event Log
- 3) Diagnostics

## Operating Manual

An example of the 'Device Info' menu is shown below.

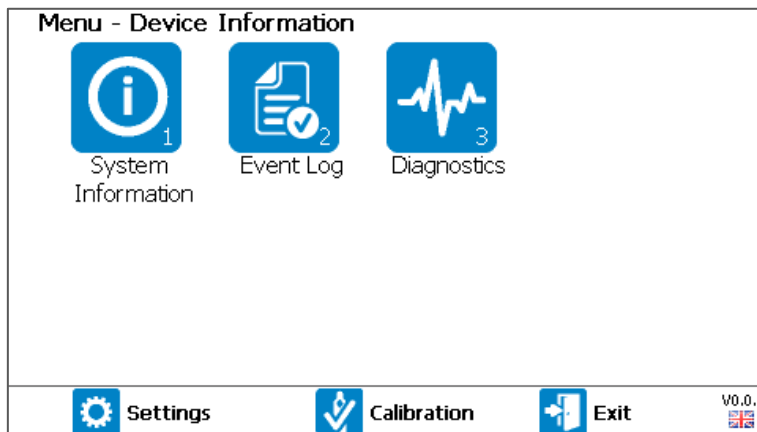

Screen 36 - Device Information menu

### System Information

This option allows the operator to view important information about their system, such as the serial number of the module, next service due date, and firmware version. This information may be required when contacting your local distributor or our technical support team for assistance.

- 1) From the 'Device Info' menu press key '1' to select the 'System Information' option.

System Information		
System Part Number:	BG3KU-0070-X1-G	
System Serial Number:	BG3K0001	
Manufacture Service:	01/01/70	
Last User Calibration:		
Main Board:	G300001	0.0.1
Sensor Board:	HW:1.0	FW: V1.20.157
Interface Board:	HW:0	FW: V1.2
Num of Sample points:	1	

Screen 37 - System Information

- 2) Press the right soft key to 'Exit' back to the 'Device Info' menu.
- 3) Use the left soft key to scroll the page down and the middle soft key to scroll the page up.

### View Event Log

The BIOMETHANE 3000 incorporates the facility to log significant events performed on the system via the event log. This can be used as an aid to monitoring the use of the system and used as a diagnostic tool if there is a problem.

The system stores the last 3,000 events. Older events are automatically deleted from the log. Applicable events are stored in the event log automatically and no user intervention is required.

## Operating Manual

- 1) From the 'Device Info' menu press key '2' to select the 'View Event Log' option.

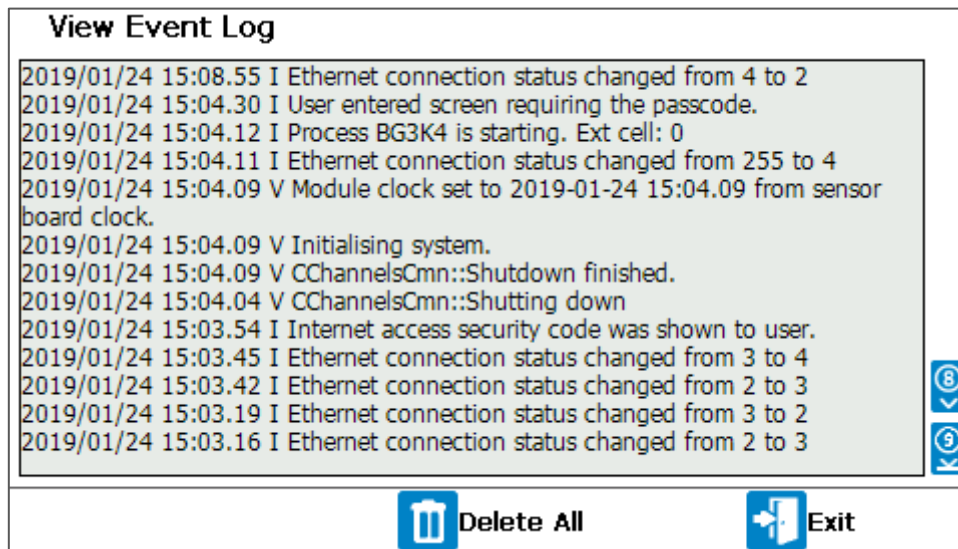

Screen 38 - View Event Log

- 2) Press the right soft key to 'Exit' back to the 'Device Info' menu.
- 3) Use keys '2' and '8' to navigate up and down through the log page.
- 4) Use keys '3' and '9' to navigate directly to the most recent or oldest entries in the event log
- 5) Press the middle soft key to 'Delete All' logs.

### Diagnostics

This option allows the operator to view the diagnostics screen. The operator may be requested to view this screen if they contact their local distributor or our technical support team for assistance.

- 1) From the 'Device Info' menu press key '3' to select the 'Diagnostics' option.

Operating Manual

Diagnostics					G300001
Channel	ADC	Filt	Lin	Linz	Status
CH <sub>4</sub> %	8142	8144	16.7	>>>	<input checked="" type="checkbox"/>
CO <sub>2</sub> %	7334	7331	0.6	0.6	<input checked="" type="checkbox"/>
O <sub>2</sub> %	46195	46197	14.9	14.9	<input checked="" type="checkbox"/>
Ref	10062	10067	10067	10067	<input checked="" type="checkbox"/>
Tbench °C	30024	30024	28.9	28.9	<input checked="" type="checkbox"/>

Next Page

Previous Page

Exit

v0.0.1

Screen 39 - Diagnostics

- 2) Press the right soft key to 'Exit' back to the 'Device Info' menu.
- 3) Use the left soft key to scroll the page down and the middle soft key to scroll the page up.

Calibration Menu

The following options are available in the calibration menu:

- 1) Gas check
- 2) Restore to Factory
- 3) Fit New Cell
- 4) Hydrocarbon Adjustment

An example of the 'Calibration' menu is shown in [Screen 40 - Calibration menu](#).

Note: If the system does not have an external sensor fitted, option three 'Fit New Cell' will not be present.

Operating Manual



Screen 40 - Calibration menu

Gas Check

The ability has been provided to perform a gas check and calibration on the gas channels of the system. This ensures the accuracy of the system in its current operating condition. To ensure optimum performance please ensure your BIOMETHANE 3000 module is returned for service and calibration on time.

Note: Selecting a mixture within this option will stop the sampling process and freeze the outputs at their last known value.

- 1) From the 'Calibration' menu press key '1' to select the 'Gas Check' option.

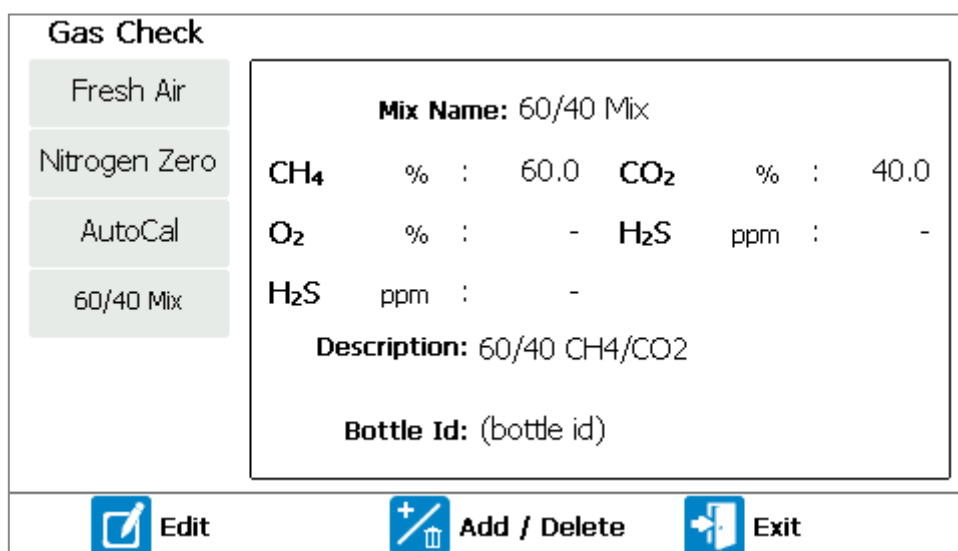

Screen 41 - Gas Check

- 2) Press the right soft key to 'Exit' back to the 'Calibration' menu.

## Operating Manual

Note: For more information on calibration, please refer to section [Gas Check and Calibration](#) in this operating manual.

### Restore to Factory

This option will reset the gas analyzer to all of its factory programmed settings and will clear all user defined calibration points.

Note: Selecting this option will stop the sampling process and freeze the outputs at their last known value.

- 1) From the 'Calibration' menu press key '2' to select the 'Restore to Factory' option.

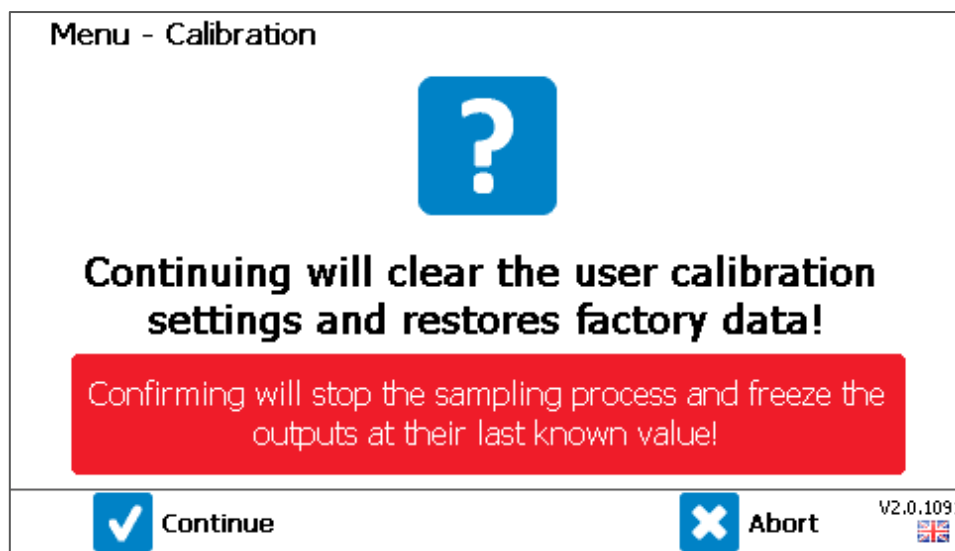

Screen 42 - Restore to Factory settings

- 2) Press the right soft key to 'Abort' which does not reset the calibration data and will return the operator to the calibration menu.
- 3) Press the left soft key to 'Continue', which resets the calibration data and will return the operator to the calibration menu.

### Fit New Cell

This option should be selected when the user has installed a new pre-calibrated external cell or external sensor module (cell complete with PCB). It over-writes the current factory calibration values with the data provided with the cell.

Note: This option will only be available for systems where an external sensor is fitted.

Note: Selecting this option will stop the sampling process and freeze the outputs at their last known value.

- 1) From the 'Calibration' menu press key '3' to select the 'Fit New Cell' option.



Operating Manual

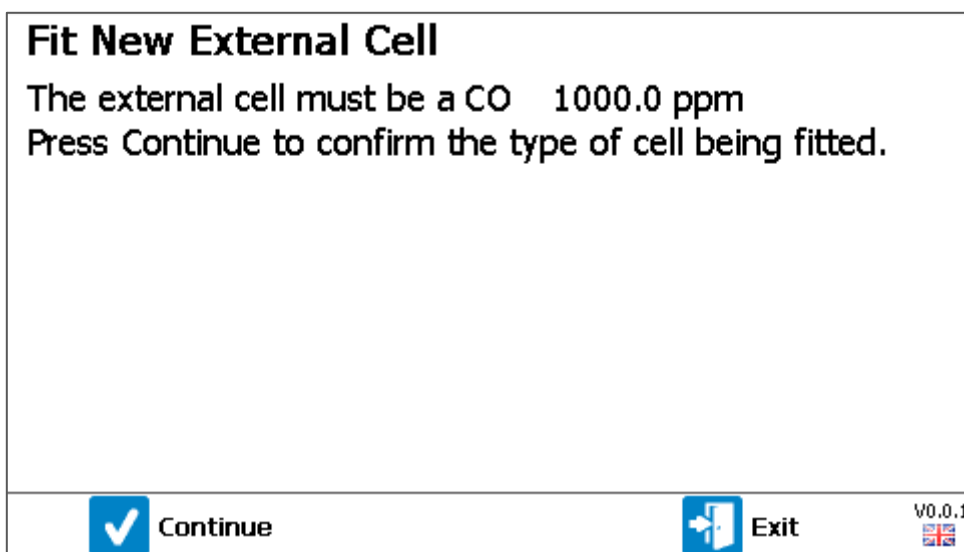

Screen 43 - Fit New External Cell confirmation

- 2) Press the right soft key to 'Exit' and return to the 'Calibration' menu.
- 3) If fitting a new cell or complete module, confirm the cell type and range, and press the left soft key to 'Continue'.

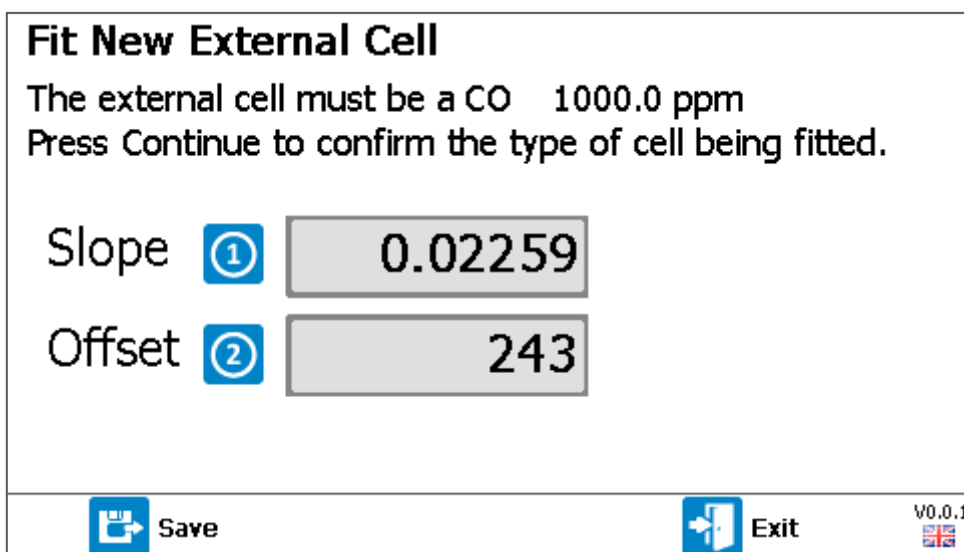

Screen 44 - Input new Slope and Offset

Note: Alongside the new cell or complete module there will be a calibration certificate containing the new slope and offset figures. Both of these values need entering in to the appropriate fields in the above screen.

- 4) Press key '1' to edit the 'Slope' or key '2' to edit the 'Offset'. Use the keypad to enter the numeric value and confirm with the ↵ key.
- 5) Press the left soft key to 'Save' the new configuration to memory. Following this, a prompt will appear advising the user to perform a calibration.

## Operating Manual

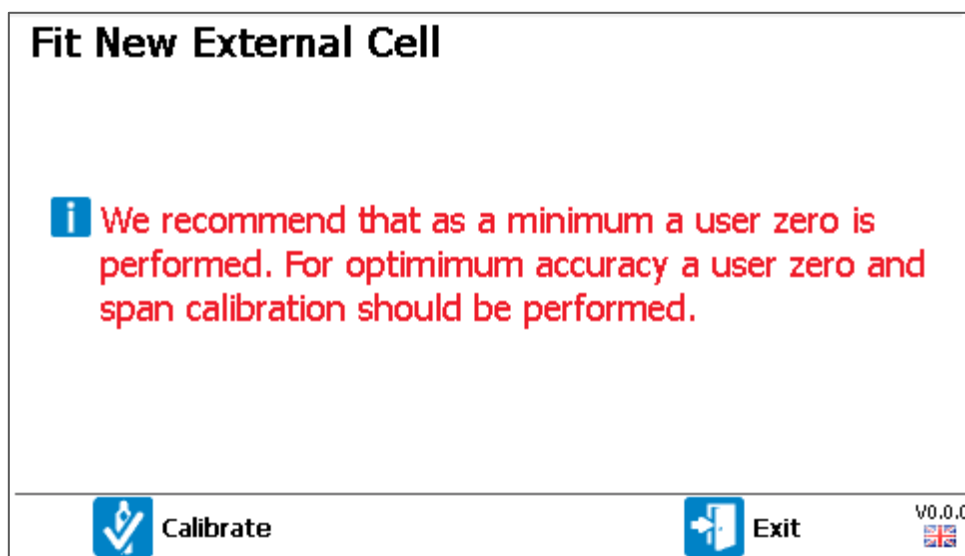

Screen 45 - User calibration recommendation

Note: After a new cell or complete module is fitted, it is recommended that as a minimum a user zero be performed. For optimum accuracy, a span calibration should be performed in addition to a zero.

- 6) Pressing the left soft key for 'Calibrate' will take the user to the 'Gas Check' screen. Pressing the right soft key to 'Exit' will return the user to the 'Calibration' menu.

### Hydrocarbon Adjustment

This option will enable or disable Hydrocarbon Adjustment, which compensates the Methane (CH<sub>4</sub>) reading to account for cross-gas effects caused by other hydrocarbons present in the gas mixture.

Note: Hydrocarbon adjustment does not replace the requirement for good calibration practice. It is strongly advised that a user calibration is performed before this option is considered, refer to section Gas Check and Calibration.

Press key '1' to toggle the option between 'enabled' or 'disabled'. Press left soft key 'Save and Exit' to save the setting preference.

The presence of a red triangle icon above the CH<sub>4</sub> reading displayed on the gas reading screen indicates when the CH<sub>4</sub> value has been adjusted, see also Gas Readings Screen.

The CH<sub>4</sub> reading is compensated to ensure the sum of the primary gas components measured does not exceed a total of 100% (e.g. % CH<sub>4</sub> + % CO<sub>2</sub> + % O<sub>2</sub> ≤ 100.0%).

## Operating Manual

**Hydrocarbon Adjustment**

**1** Adjust CH<sub>4</sub> for effects of hydrocarbons:

**Disabled**

In some cases, the Methane (CH<sub>4</sub>) reading can be affected by other gases not measured by this instrument.

Ensure that the instrument is correctly calibrated before considering this option.

Enable this option to compensate for the effect of other gases on CH<sub>4</sub>. The reading will be reduced so that the sum of CH<sub>4</sub> + CO<sub>2</sub> + O<sub>2</sub> is 100.0%.



*Screen 46 – Hydrocarbon Adjustment*

Operating Manual

BIOMETHANE 3000 Sampling Process

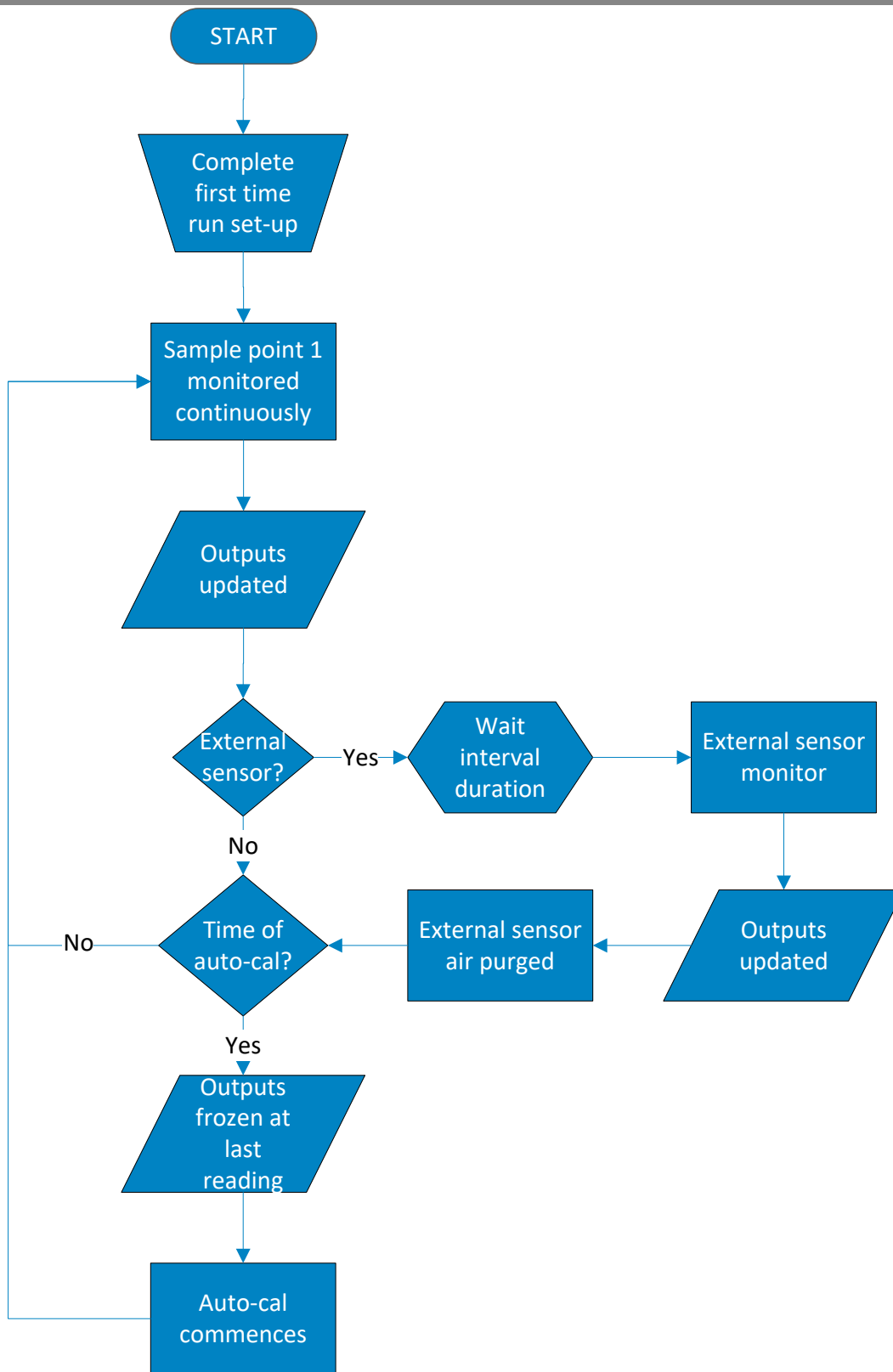

Flow Chart 1 - BG3KU

## Operating Manual

### Switching the BIOMETHANE 3000 System Off

The BIOMETHANE 3000 system can only be turned off at the switched mains supply that is installed in section [Protective Grounding and Mains Supply – BIOMETHANE 3000 System](#).

The BIOMETHANE 3000 module can be turned off independently to the system. To do this, press and hold the on/off key for approximately two seconds. This will close all solenoids, switch off all pumps, trigger the fault relay, and freeze the outputs at their last known value. Power will remain to the system.

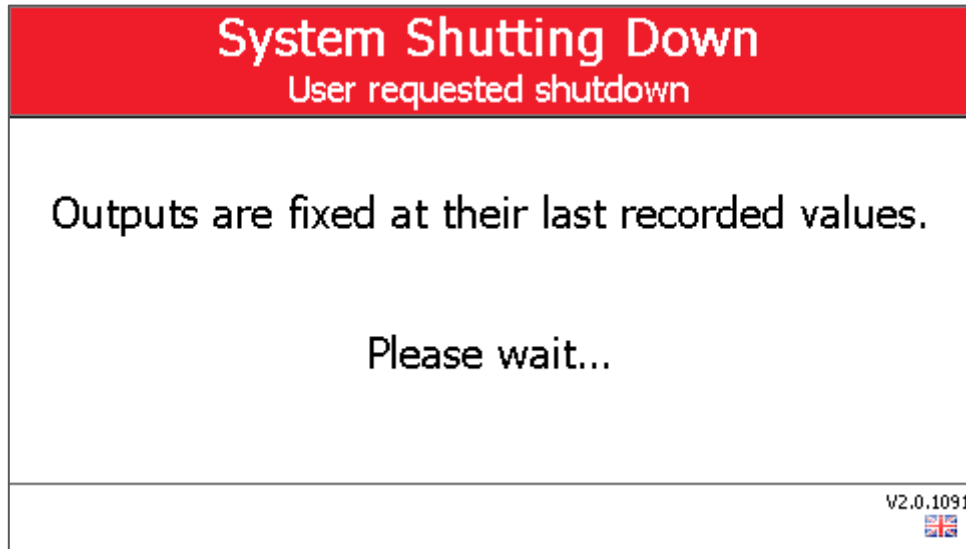

Screen 47 - Power off

## Operating Manual

**GAS CHECK AND CALIBRATION**

Do not open when an explosive atmosphere is present.

**Introduction**

The BIOMETHANE 3000 system is carefully calibrated at manufacture and when returned for service using a number of gas concentrations and temperature points.

The BIOMETHANE 3000 system utilizes an auto-calibration function that occurs at user definable frequencies to improve its accuracy and provide more confidence.

The BIOMETHANE 3000 measures CH<sub>4</sub>, CO<sub>2</sub>, and O<sub>2</sub> as standard with optional additional gases and these channels will be auto-calibrated.

In addition, these channels can also be gas checked and if required, manually calibrated to improve the accuracy in the range of the gas concentration used.

This section will describe in detail the correct procedure to gas check and calibrate these gas channels.

**Note:** This does not replace the factory service and calibration.

**Note:** If this calibration is completed incorrectly, it may decrease the accuracy of the system.

Six important terms that are used within this section are:

**Gas check:** This is where a known concentration of gas is applied to the system and its responses are checked with no adjustment being made.

**Calibration:** This is when an adjustment is made to the modules readings after a gas check has been performed, by either a zero, span, or both, by either an auto-calibration process or a manual calibration process.

**Auto-calibration:** The system will perform a zero and/or span using a known gas mixture without user intervention at pre-determined frequencies.

**Manual calibration:** The system will perform a zero and/or span using a known gas mixture when instructed to do so by the operator.

**Zero:** The point at which the system is calibrated when there is none of the target gas present.

**Span:** The point at which the system is calibrated when there is a known concentration of the target gas present.

**Note:** A more detailed explanation of user calibration can be found in section [User Calibration Explained](#).

## Operating Manual

### Required Equipment

#### Gas

Calibration of the system will greatly improve the data accuracy in the range of the calibration gas used and the environmental conditions for which the BIOMETHANE 3000 is calibrated. Calibrating at these concentrations may cause less accurate readings outside of this calibrated range.

Users should select the correct calibration gas for the expected gas levels on their particular application. For the BIOMETHANE 3000, this may be 100% CH<sub>4</sub>. In addition, nitrogen (N<sub>2</sub>) can be used for a zero calibration. If this is not available, then clean ambient air can be used.

For the BIOMETHANE 3000, there are two types of gas bottles that can be used for an auto-calibration, a disposable, non-refillable cylinder (these can be purchased from QED) or a non-disposable, refillable cylinder (these are typically rented from organizations such as BOC or Air Liquide).



Calibration gases can be dangerous. For each gas used, the appropriate material safety data sheet / safety data sheet must be read and fully understood before proceeding.

### Flow Regulator

#### Auto-Calibration System

The auto-calibration system comes fitted with a pressure regulator that regulates the gas supply to typically 83in.H<sub>2</sub>O (3psi, 207mbar). In addition, a flow control meter is fitted delivering a flow to the BIOMETHANE 3000 system of typically 300cc/min (300ml/min). This is user adjustable.

The auto-calibration system has pressure relief valves incorporated to protect the BIOMETHANE 3000 system from over-pressurization on both the high pressure and low pressure lines.



When the system is being calibrated, in cases of over-pressurization, the pressure relief valve will release gas to protect the BIOMETHANE 3000 module. It is recommended that the exhaust tubing from the pressure relief valve emerge in a well-ventilated area.

Ensure there are no leaks in the tubing and connections before carrying out a calibration.

#### Manual Calibration

It is recommended that the regulator available via QED be used as it has been configured to deliver a fixed flow of 300ml/min and correct pressure relief to avoid damage to the system (see QED part number GA6.8 in [BIOMETHANE 3000 Consumable Products](#)). As the regulator's flow is factory set it only requires a few turns to open, no adjustment will be necessary.

**Note:** If using a regulator that was not supplied by QED please ensure the flow rate is adjusted to a maximum of 300cc/min (300ml/min). Suitable pressure relief should be used to protect the system from damage because of over-pressurization – typically 80-140in.H<sub>2</sub>O (200-350mbar, 3-5psi).

## Operating Manual



When the system is being calibrated, in cases of over-pressurization, the 1/16" port on the red pressure relief valve (supplied with the QED pressure regulator) will release gas to protect the BIOMETHANE 3000 module. It is recommended that the exhaust tubing from the pressure relief valve emerge in a well-ventilated area.

Ensure there are no leaks in the tubing and connections before carrying out a user calibration.

The calibration of the BIOMETHANE 3000 should be carried out by trained personnel taking all necessary precautions when using dangerous, explosive, or toxic gases.

### Gas Mixtures

The BIOMETHANE 3000 provides the user with the ability to add, edit, or delete gas mixtures that can be used for the gas check and calibration process. There are four default mixtures:

- Fresh Air – assumed values of fresh air are CH<sub>4</sub> 0.0%, O<sub>2</sub> 20.8, and all other optional gasses 0ppm. CO<sub>2</sub> is not available to calibrate in air.

**Note:** The oxygen concentration is editable between 20.8% and 21.0% - see [Edit O<sub>2</sub> in Fresh Air Mix.](#)

- Nitrogen Zero – known values of CH<sub>4</sub> 0.0%, CO<sub>2</sub> 0.0%, O<sub>2</sub> 0.00%, and all other optional gasses 0ppm.

**Note:** If zeroing the CO<sub>2</sub> channel, the countdown timer will increase from three minutes to five.

- AutoCal – default values of CH<sub>4</sub> 100.0%, O<sub>2</sub> 0.00%, and all other optional gasses 0ppm. CO<sub>2</sub> is not zeroed by default but the mixture is editable by the user to perform this operation.

**Note:** If zeroing the CO<sub>2</sub> channel, to obtain maximum accuracy, ensure the channel is also span calibrated by way of a manual calibration.

- 60/40 Mix – default values of CH<sub>4</sub> 60.0% and CO<sub>2</sub> 40.0%. O<sub>2</sub> and all other optional gasses are not zeroed by default but the mixture is editable by the user to perform this operation.

**Note:** The CH<sub>4</sub> and CO<sub>2</sub> values should be edited with the true bottle concentration.



Operating Manual

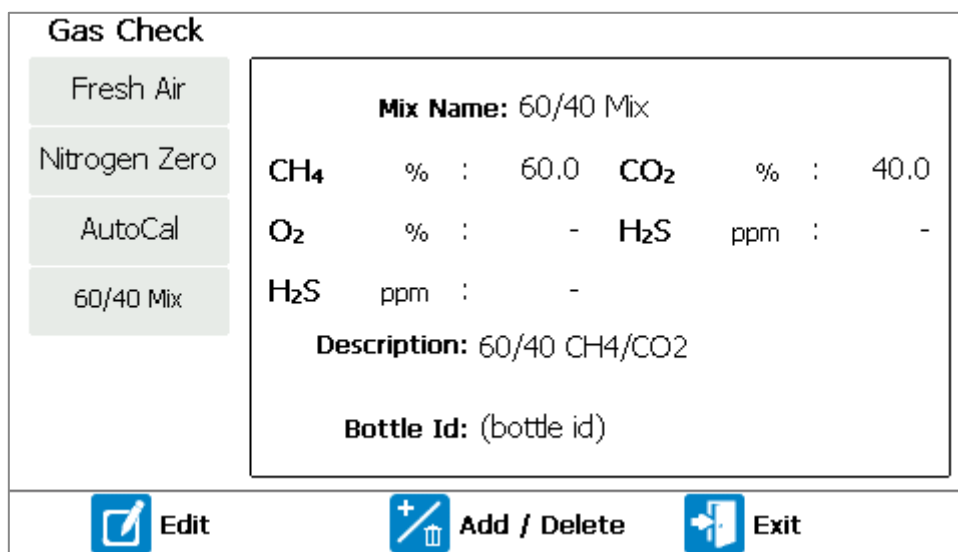

Screen 48 - Gas Check

Adding a Mixture

In addition to the four default mixtures, the BIOMETHANE 3000 also supports the addition of two user definable mixtures. To add a mix:

- 1) In the 'Gas Check' screen, press the middle soft key to 'Add' a mix.

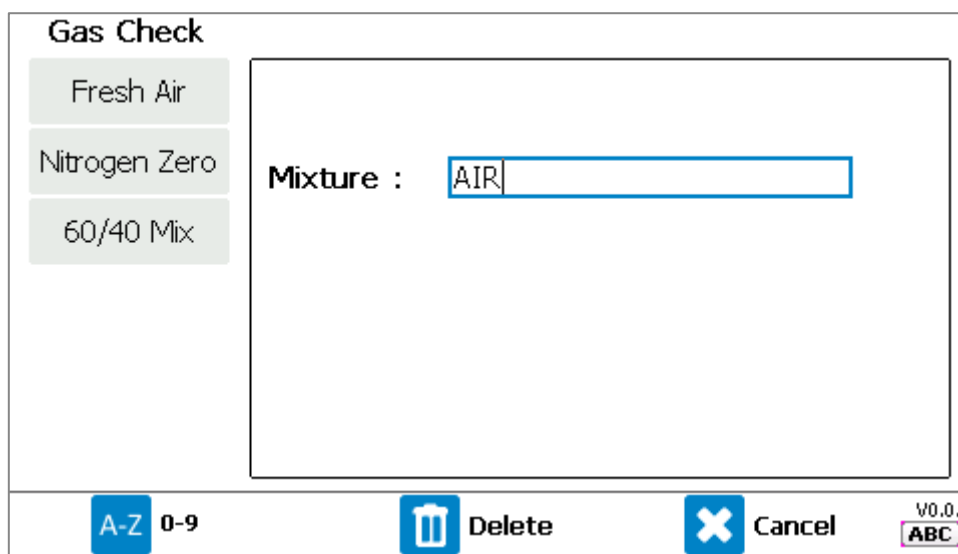

Screen 49 - Add gas mixture

- 2) Using the keypad, enter a name for the mixture. Pressing the left soft key toggles between letter and number entry. Press ↵ when complete.

Operating Manual

**Edit Gas Mix**

Name:

Description:

Bottle Id:

<b>CH<sub>4</sub></b>	(%) :	<input type="text" value="-"/>	<b>CO<sub>2</sub></b>	(%) :	<input type="text" value="-"/>
<b>O<sub>2</sub></b>	(%) :	<input type="text" value="-"/>	<b>H<sub>2</sub></b>	(ppm) :	<input type="text" value="-"/>



**Save and  
Exit**



**Exit**

V0.0.0  

Screen 50 - Edit gas mix details

3) Using the scroll keys, select an editable field and press the ← key to edit:

- Name, Description and Bottle ID are text and number fields
- Gas channels are number fields. Enter the gas concentration of the bottle in percent or ppm. A '-' will not perform an action on the channel. Entering a gas concentration will span the channel, entering a '0' will zero the channel.

4) Press the middle soft key to 'Save and Exit'.

**Note:** The gas concentrations for the 60/40 Mix and the two customer definable mixtures are editable using the left soft key when highlighting the mix in the 'Gas Check' screen.

Deleting a Mix

**Note:** The four default mixtures cannot be deleted.

To delete a gas mix in the 'Gas Check' screen:

- 1) Use the scroll keys to highlight the mix to be deleted.
- 2) Press the middle soft key to 'Add/Delete'.

Operating Manual



Screen 51 - Add or delete mix

- 3) Press the middle soft key to 'Delete'.
- 4) Press the left soft key 'Yes' to confirm deletion.

Edit O2 in Fresh Air Mix

The concentration of oxygen in the fresh air mix is editable between 20.8 and 21.0%. To change the concentration used:

- 1) Highlight the 'Fresh Air' mix.
- 2) Press the left soft key to edit the 'Oxygen Level'.

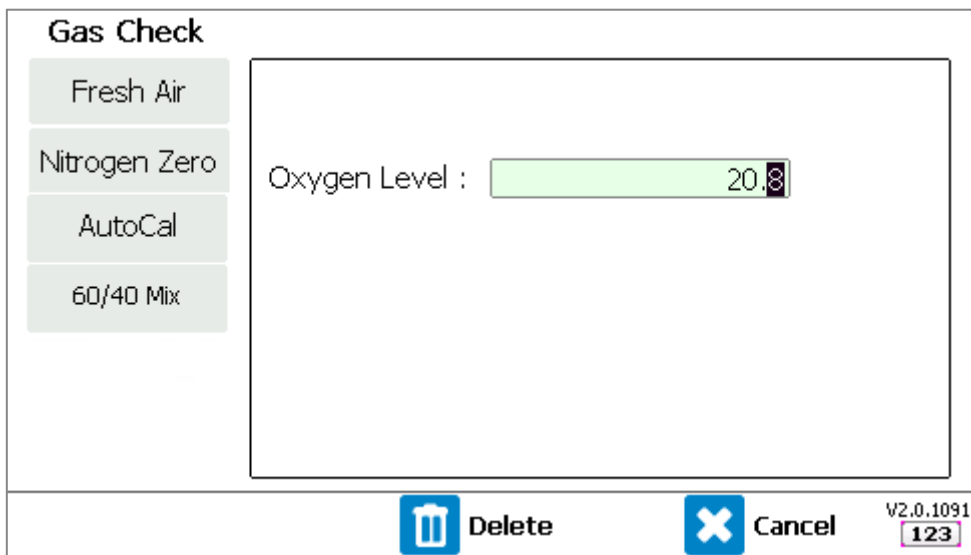

Screen 52 - Edit oxygen concentration

- 3) Pressing the right soft key will 'Cancel' the edit.

## Operating Manual

- 4) Key in the concentration you wish to span the oxygen channel to in fresh air, followed by the ← key to confirm. The operator will be returned to the 'Gas Check' screen.

### Connecting a Gas Bottle to the BIOMETHANE 3000 for a Manual Calibration

This section explains how to connect a gas bottle to the BIOMETHANE 3000 system in preparation for a manual gas check or calibration.

**Note:** For guidance on how to replace the auto-calibration disposable gas cylinder, please refer to section [Fitting/Replacing the Disposable Gas Cylinder](#).





Do not open when an explosive atmosphere is present.



Mains voltages are present within the BIOMETHANE 3000 system and great care needs to be observed. If there is any uncertainty, seek advice from a professional.

Pressurized gas bottles can be dangerous and great care needs to be taken when in use.

Alternatively, contact your local distributor, or our technical support team at QED at (800) 624-2026 or email [service@qedenv.com](mailto:service@qedenv.com) to arrange a site visit. (Please note a charge may be applicable.)

Op.	Image	Instruction
1		<p>Ensure the drain valve is closed.</p> <div style="border: 1px solid purple; padding: 5px; margin-top: 10px;"> <p><b>Note:</b> Auto-drain systems will not have a ball valve.</p> </div>
2		<p>Ensure the gas inlet and gas outlet valves are closed.</p>

Operating Manual

3		<p>Disconnect the QRC from the top of the catchpot.</p>
4		<p><b>Note:</b> Ensure the pressure regulator is turned off.</p> <p>Attach the pressure regulator to the gas bottle and ensure it is adequately tightened.</p>

Ensure that the regulator is fitted to the bottle at arm's length in case of a gas leak.

Ensure that no cross threading occurs during tightening of the regulator.

 During the rare occasion that gas does leak from the seal, place the bottle and regulator on the floor and leave the area until the leak has stopped. **DO NOT** attempt to solve the leak as this could be dangerous.

5		<p>Ensure that the gas bottle has adequate pressure (i.e. is not empty).</p>
---	---	--

## Operating Manual

6		Attach the tubing from the gas bottle and regulator to the QRC.
---	---	---

Gas Check and Calibration  
Auto-Calibration

**Note: The 'AutoCal' gas mixture does not provide the user with the opportunity to check the accuracy of the system.**

After the BIOMETHANE 3000 system has been installed and pressure tested, it is recommended that an auto-calibration be performed to ensure its accuracy, as drift could have occurred during installation and/or transit. This option is presented to the operator as part of the first time configuration.

In addition, as part of the first time configuration, the operator can define the frequency to which the auto-calibration occurs. The timings for this are configurable in [Auto-Calibration Settings](#).

At the frequency set by the operator, the monitoring process will be paused and the auto-calibration step will commence. At this point, the gas is passed through the system and module for the defined amount of time. Once elapsed, the gas channels are zeroed and/or spanned accordingly.

Manual Gas Check and Calibration

**Note: The 'AutoCal' gas mixture does not provide the user with the opportunity to check the accuracy of the system.**

A gas check can be performed as part of regular maintenance to validate the accuracy of the system and determine whether a user calibration is required.

The gas used for a check or calibration should be representative of the gas within the application, for example, 0.50% O<sub>2</sub>.

The BIOMETHANE 3000 performs a gas check before providing the user with a decision. If the result of the check is that the instruments accuracy is good, a calibration may not need to be performed. At this point, the user can decide to record the results and exit. Alternatively, the accuracy may need improving and at this point, the user can decide to correct the errors by way of a user calibration. This will adjust the figures and record the calibration to memory.

[Flow Chart 2 - Gas Check and Calibration](#) is a simple overview of the process:

Operating Manual

Note: It is QED's recommendation that a zero check and calibration is carried out before a span check and calibration.

Note: When selecting a mixture in the 'Gas Check' screen, the sampling process will be stopped.

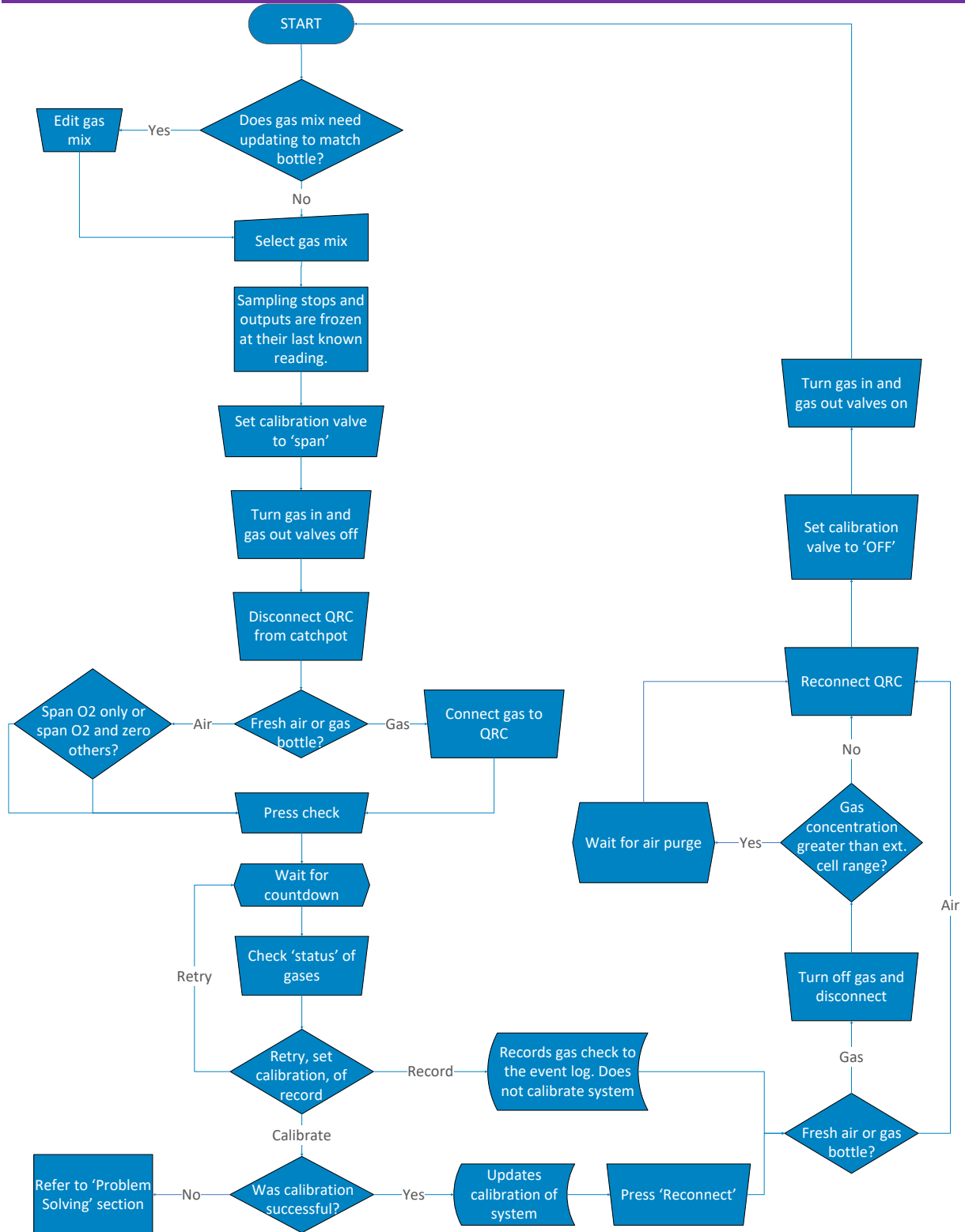





Flow Chart 2 - Gas Check and Calibration

## Operating Manual



### Status Icons

Below is a list of status icons used after the gas check and calibration processes and their definition:

#### Post Gas Check

Icon	Definition
	Channel has not been checked
	Recommends a calibration be performed
	Channel is outside of limits – see <a href="#">User Calibration</a> Explained
	Channel is within limits and may not need adjusting

#### Post Calibration

Icon	Definition
	Channel has not been checked
	Channel was not calibrated due to an error – see <a href="#">User Calibration</a> Explained
	Channel was calibrated OK



## Operating Manual

### Disconnecting a Gas Bottle from the BIOMETHANE 3000

This section explains how to disconnect a gas bottle from the BIOMETHANE 3000 system following a manual gas check or calibration.



Do not open when an explosive atmosphere is present.

Mains voltages are present within the BIOMETHANE 3000 system and great care needs to be observed. If there is any uncertainty, seek advice from a professional.



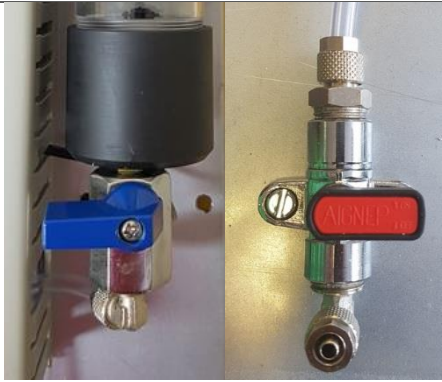

Pressurized gas bottles can be dangerous and great care needs to be taken when in use.

Alternatively, contact your local distributor, or our technical support team at QED at (800) 624-2026 or email [service@qedenv.com](mailto:service@qedenv.com) to arrange a site visit. (Please note a charge may be applicable.)

Op.	Image	Instruction
1	No image	Ensure the pressure regulator is turned off.
2		Ensure the drain, gas inlet and gas outlet valves are still closed.
3		Ensure the gas bottle supply is turned off and disconnect the tubing of the gas bottle and regulator from the QRC.

Operating Manual

4		<p>Reconnect the system tubing by connecting the QRC to the top of the catchpot.</p> <p><b>Note: Ensure that the coupling ‘clicks’ in to place.</b></p>
5	No image	<p>Remove the regulator from the gas bottle and store both appropriately to avoid damage.</p>
6		<p>Open the gas inlet and gas outlet valves.</p> <p><b>Note: The drain valve is to remain closed.</b></p>



It is critical that the connections are fully secured to ensure that no gas leaks in to the main enclosure.

Once the BIOMETHANE 3000 tubing has been reconnected, it is recommended that a [Pressure Test](#) be completed to ensure that the system is leak free.

## Operating Manual

### MAINTENANCE

This section outlines the maintenance requirements which the operator needs to perform on the system and instructions for user replaceable components.

**Note:** For further information please contact your local distributor, or our technical support team at QED at (800) 624-2026 or email [service@qedenv.com](mailto:service@qedenv.com).

Do not open when an explosive atmosphere is present.



The use of non-QED approved parts being fitted to the equipment may cause a hazard, invalidate the hazardous area certification, and any remaining warranty.

The system should not be altered in any way other than described in this operating manual. Alterations outside of this operating manual could cause a hazard, make the equipment unsafe voiding the warranty and ATEX/IECEX certification.

### Maintenance Schedule

**Note:** This maintenance schedule is a minimum guide and dependent upon the application, location (including local laws and regulations), and usage of the BIOMETHANE 3000 system, may need to be adapted accordingly.

As a minimum, QED recommend that each month the following be undertaken to ensure the BIOMETHANE 3000 system is in its optimum working and safe condition:

- Inspect the BIOMETHANE 3000 and auto-calibration systems for damage
- Review the installation location for continued suitability (i.e. physical and environmental conditions)
- Check the main enclosure gaskets for damage to ensure the IP rating can be maintained
- Inspect the interior of the enclosure for damage or condensation (particularly in territories with high humidity)
- Ensure screws have remained tightened to the recommended torque settings below and there are no visible signs of corrosion

Type	Torque ( N·m)
M3	0.5
M4	1.1
M6	4.0
M8	10
DIN Rail Terminals/Connectors	0.6
Terminal Block Connectors	0.2

## Operating Manual



All terminals including unused terminals shall be tightened as per the operating manual.

Failure to meet the above requirements could make the equipment unsafe resulting in a hazard and invalidate the hazardous area certification.

- Empty the catchpot (see [Emptying the Catchpot](#))
- Inspect, and replace if required, the coalescing catchpot filter (see [Replacing the Catchpot Filter](#))
- Inspect, and replace if required, the inline PTFE filter (see [Replacing the Inline PTFE Filter](#))
- Check the gas bottle regulators have remained at the correct pressure and creepage is not occurring
- Perform a pressure test to ensure there are no leaks (see [Pressure Test](#))
- Perform a gas check to determine the accuracy of the system and if required a calibration (see [Gas Check and Calibration](#)).

As a minimum, QED recommend that in accordance with local electrical regulations, the following be undertaken to ensure the BIOMETHANE 3000 system is in its optimum working and safe condition:

- Ground bond test
- Insulation test

Note: It is the operator's responsibility to keep a record of when and what maintenance has been performed.

Note: If you suspect the BIOMETHANE 3000 system to have been damaged and are unsure of the consequences of this, please contact your local distributor, or our technical support team at QED at (800) 624-2026 or email [service@qedenv.com](mailto:service@qedenv.com).

Note: Inspection of the catchpot and inline filter may be required more frequently depending upon the application and the likelihood of liquid in the sample gas.

Note: After performing a gas check or calibration, it may be necessary to perform a further pressure test on the equipment to ensure it has remained leak free.



Dependent upon the application, the equipment can come in to contact with unsafe contaminants. It is therefore recommended that suitable PPE is identified and worn (such as gloves) and hands are washed thoroughly after maintenance is completed.

Operating Manual

BIOMETHANE 3000 Consumable Products

Optional replacement parts may be purchased for the BIOMETHANE 3000 from your local distributor or QED directly. Refer to the next page for part numbers:



## Operating Manual

Ref	Description	Part Number
A	Catchpot with coalescing filter and built-in valve for systems without auto-drain	BG3K.S1
	Catchpot with coalescing filter and drainage tubing for systems with auto-drain	BG3K.S2
B	BIOMETHANE 3000 Profibus option	BG3K.S3
	BIOMETHANE 3000 Profinet option	BG3K.S4
	BIOMETHANE 3000 Ethernet option	BG3K.S40
C	Filter, Exhaust 1/4 MNPT (used as air purge filter)	2008277/S
D	Inline PTFE filters (pack of 10)	GA4.2
	Inline PTFE filters (pack of 30)	GA4.2(30)
E	Pre-calibrated external sensor module	Please contact us
F	Calibration gas	Please contact us
	Check gas regulator* used in conjunction with calibration gas canister. This valve controls the flow of gas – c/w safety valve.	GA6.8
G	Pre-calibrated external sensor	Please contact us
H	5m length 4mm I.D tubing	GA3K.S6
I	Coalescing filter for catchpot x 5	GA3K.S1
J	Fuses	Please contact us
K	External catchpot option	GA3KP.S15
L	Pressure regulator for fixed systems, input pressure max 50BarG, output Range 0.05 – 1 BarG	BG3K.S52
M	BIOGAS 3000 Pressure Test Kit	5015062-US

**Note: \* the pressure regulator is for use with canisters used for a manual calibration.**

# Operating Manual

## Emptying the Catchpot

Do not open when an explosive atmosphere is present.





Mains voltages are present within the BIOMETHANE 3000 system and great care needs to be observed. If there is any uncertainty, seek advice from a professional or isolate the supply. Alternatively, contact your local distributor, or our technical support team at QED at (800) 624-2026 or email [service@qedenv.com](mailto:service@qedenv.com) to arrange a site visit. (Please note a charge may be applicable.)

**Note:** This process is only applicable for systems without auto-drain.

Op.	Image	Instruction																																			
1	<table border="1" style="margin: 10px auto; border-collapse: collapse; text-align: center;"> <thead> <tr style="background-color: #003366; color: white;"> <th>Output</th> <th>SP</th> <th>Gas</th> <th>Reading</th> <th>mA</th> </tr> </thead> <tbody> <tr> <td>1</td> <td>1</td> <td>CO2</td> <td>0.0</td> <td>4.0</td> </tr> <tr> <td>2</td> <td>All</td> <td>O2</td> <td>5.5</td> <td>7.5</td> </tr> <tr> <td>3</td> <td></td> <td>(Disabled)</td> <td></td> <td></td> </tr> <tr> <td>4</td> <td></td> <td>(Disabled)</td> <td></td> <td></td> </tr> <tr> <td>5</td> <td></td> <td>(Disabled)</td> <td></td> <td></td> </tr> <tr> <td>6</td> <td></td> <td>(Disabled)</td> <td></td> <td></td> </tr> </tbody> </table>	Output	SP	Gas	Reading	mA	1	1	CO2	0.0	4.0	2	All	O2	5.5	7.5	3		(Disabled)			4		(Disabled)			5		(Disabled)			6		(Disabled)			<p>From the 'Gas Readings Screen', press the middle soft key to 'Stop Sampling'.</p> <div style="border: 1px solid purple; padding: 5px; margin-top: 10px;"> <p><b>Note:</b> If required, press the middle soft key once more to fix the outputs at their safe values.</p> </div>
Output	SP	Gas	Reading	mA																																	
1	1	CO2	0.0	4.0																																	
2	All	O2	5.5	7.5																																	
3		(Disabled)																																			
4		(Disabled)																																			
5		(Disabled)																																			
6		(Disabled)																																			
2		<p>Ensure the drain, gas inlet, and gas outlet valves are closed.</p>																																			
3		<p>Disconnect the QRC from the top of the catchpot.</p>																																			

Operating Manual

4		<p>Open the drain valve to allow liquid to empty from the catchpot.</p>
---	---	---

 The catchpot can hold approximately 90ml of liquid. Dependent upon the application the liquid removed may be contaminated and should be discharged to an area where it is safe to do so.

This line may also vent sample gas for a brief period during each draining operation if the sample inlet and gas out valves are not closed.

5		<p>Once the catchpot has emptied, close the drain valve.</p>
---	--	--

6		<p>Reconnect the system tubing by connecting the QRC to the top of the catchpot.</p> <div style="border: 1px solid purple; padding: 5px; margin-top: 10px;"> <p><b>Note:</b> Ensure that the coupling 'clicks' in to place.</p> </div>
---	---	--

 It is critical that the connections are fully secured to ensure that no gas leaks in to the main enclosure.

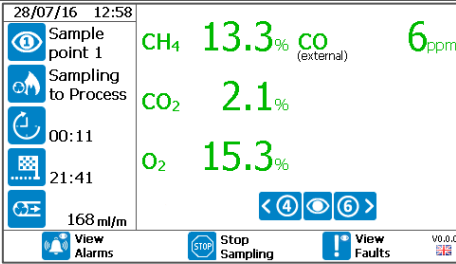

Operating Manual

7		Open the gas inlet and gas outlet valves.
8		From the sampling stopped screen, press the left soft key to 'Restart' the monitoring process and return to the 'Gas Readings Screen'.

 Once all maintenance is completed, it is recommended that a [Pressure Test](#) be completed to ensure that the system is leak free.

Operating Manual

Replacing the Catchpot Filter







Do not open when an explosive atmosphere is present.

Mains voltages are present within the BIOMETHANE 3000 system and great care needs to be observed. If there is any uncertainty, seek advice from a professional or isolate the supply. Alternatively, contact your local distributor, or our technical support team at QED at (800) 624-2026 or email [service@qedenv.com](mailto:service@qedenv.com) to arrange a site visit. (Please note a charge may be applicable.)



The coalescing catchpot filter should be replaced if showing signs of contamination. Failure to replace the filter will result in the gas flow being restricted or blocked to the BIOMETHANE 3000 module. In addition, it will cause a flow fail error.

Op.	Image	Instruction
1	No image	Drain the catchpot of any contents. Refer to <a href="#">Emptying the Catchpot</a> .
2		From the 'Gas Readings Screen', press the middle soft key to 'Stop Sampling'. <b>Note: If required, press the middle soft key once more to fix the outputs at their safe values.</b>
3		Ensure the drain, gas inlet, and gas outlet valves are closed.
4		Disconnect the gas in and gas out tubes from the catchpot assembly.

Operating Manual

5		<p>Remove the catchpot from its clip.</p>
6		<ol style="list-style-type: none"> <li>1) Unscrew the catchpot top by turning a quarter turn anti-clockwise.</li> <li>2) Lift the top from the body.</li> </ol>
7		<p>Unscrew the filter stop from underneath the filter.</p> <div style="border: 1px solid purple; padding: 5px; margin-top: 10px;"> <p>Note: Keep the filter stop safe.</p> </div>
8		<p>Remove the coalescing filter from the threaded bar and replace with new.</p>

Operating Manual

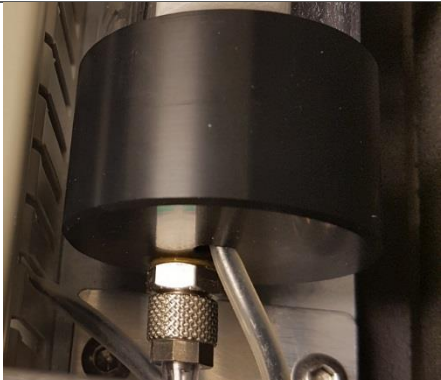
<p>9</p>		<p>Replace the filter stop and tighten into place.</p>
<p>10</p>		<ol style="list-style-type: none"> <li>1) Align and fit the catchpot top to the body.</li> <li>2) Tighten the catchpot top by turning a quarter turn clockwise.</li> </ol>
<p>11</p>		<p>Fit the catchpot back in to its clip.</p>
<p>12</p>		<p>Gently position the catchpot so that the drain tube is closest to the backplate and the female QRC is facing the front.</p>

Operating Manual

13		<p>Once secure, reconnect the couplings to the catchpot top, ensuring the tubing is not trapped or kinked.</p> <p><b>Note:</b> Ensure that the couplings 'clicks' in to place.</p>
----	---	--

 It is critical that the connections are fully secured to ensure that no gas leaks in to the main enclosure.

14		<p>Open the gas inlet and gas outlet valves.</p>
----	--	--

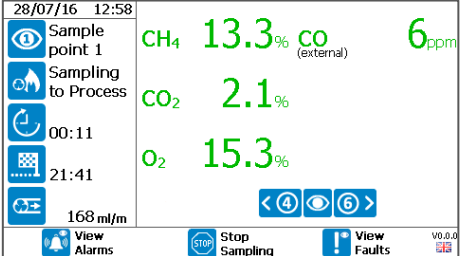
15		<p>From the sampling stopped screen, press the left soft key to 'Restart' the monitoring process and return to the 'Gas Readings Screen'.</p>
----	---	---

 Once all maintenance is completed, it is recommended that a [Pressure Test](#) be completed to ensure that the system is leak free.



# Operating Manual

Replacing the Inline PTFE Filter

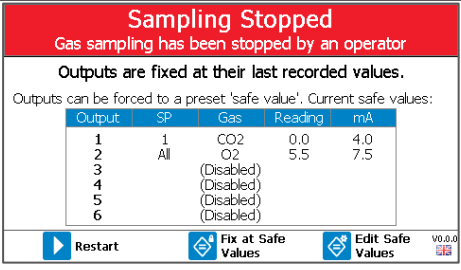
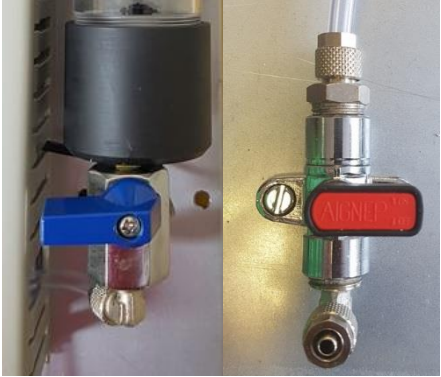

Do not open when an explosive atmosphere is present.

 Mains voltages are present within the BIOMETHANE 3000 system and great care needs to be observed. If there is any uncertainty, seek advice from a professional or isolate the supply. Alternatively, contact your local distributor, or our technical support team at QED at (800) 624-2026 or email [service@qedenv.com](mailto:service@qedenv.com) to arrange a site visit. (Please note a charge may be applicable.)

The inline PTFE filter should be replaced if showing signs of contamination or saturated with liquid. Failure to replace the filter will result in the gas flow being restricted or blocked to the BIOMETHANE 3000 module. In addition, it will cause a flow fail error.

Op.	Image	Instruction																																			
1	 <table border="1" style="margin: 10px auto; border-collapse: collapse; font-size: 8px;"> <thead> <tr style="background-color: #000080; color: white;"> <th>Output</th> <th>SP</th> <th>Gas</th> <th>Reading</th> <th>mA</th> </tr> </thead> <tbody> <tr> <td>1</td> <td>1</td> <td>CO2</td> <td>0.0</td> <td>4.0</td> </tr> <tr> <td>2</td> <td>All</td> <td>O2</td> <td>5.5</td> <td>7.5</td> </tr> <tr> <td>3</td> <td></td> <td>(Disabled)</td> <td></td> <td></td> </tr> <tr> <td>4</td> <td></td> <td>(Disabled)</td> <td></td> <td></td> </tr> <tr> <td>5</td> <td></td> <td>(Disabled)</td> <td></td> <td></td> </tr> <tr> <td>6</td> <td></td> <td>(Disabled)</td> <td></td> <td></td> </tr> </tbody> </table>	Output	SP	Gas	Reading	mA	1	1	CO2	0.0	4.0	2	All	O2	5.5	7.5	3		(Disabled)			4		(Disabled)			5		(Disabled)			6		(Disabled)			<p>From the 'Gas Readings Screen', press the middle soft key to 'Stop Sampling'.</p> <div style="border: 1px solid purple; padding: 5px; margin-top: 10px;"> <p><b>Note: If required, press the middle soft key once more to fix the outputs at their safe values.</b></p> </div>
Output	SP	Gas	Reading	mA																																	
1	1	CO2	0.0	4.0																																	
2	All	O2	5.5	7.5																																	
3		(Disabled)																																			
4		(Disabled)																																			
5		(Disabled)																																			
6		(Disabled)																																			
2		<p>Ensure the drain, gas inlet, and gas outlet valves are closed.</p>																																			
3		<p>The inline PTFE filter is located above the catchpot.</p>																																			

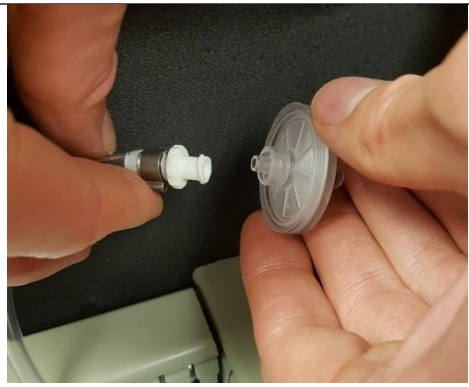
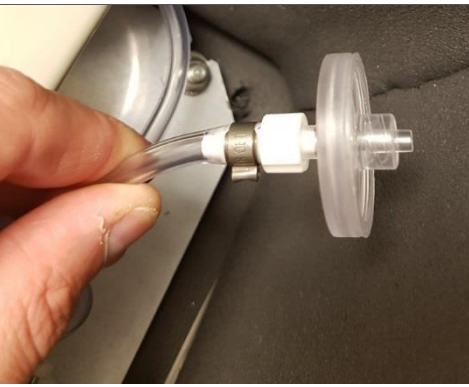
Operating Manual

4		<p>Disconnect one side of the tubing from the filter by turning anti-clockwise.</p>
5		<p>Disconnect the remaining tubing length from the filter by turning anti-clockwise.</p>
6		<p>Connect the new filter to the tubing by turning clockwise.</p>
7		<p>Connect the remaining tube to the filter by turning clockwise.</p>





Operating Manual

8		Position the tubing assembly above the catchpot ensuring the tubing is not trapped or kinked.
---	---	---

 It is critical that the connections are fully secured to ensure that no gas leaks in to the main enclosure.

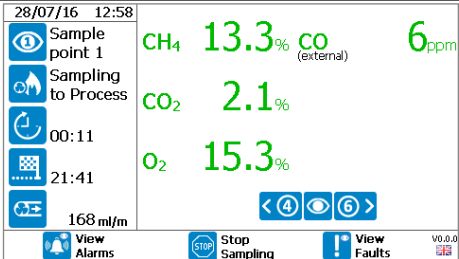
9		Open the gas inlet and gas outlet valves.
---	--	---

10		From the sampling stopped screen, press the left soft key to 'Restart' the monitoring process and return to the 'Gas Readings Screen'.
----	---	--

 Once all maintenance is completed, it is recommended that a [Pressure Test](#) be completed to ensure that the system is leak free.



## Operating Manual

### Pressure Test



Gas leaking into the enclosure could create a potentially explosive atmosphere. It is the user's responsibility to ensure that routine pressure tests are performed after installation and as part of regular maintenance.

Failure to perform routine pressure tests or a pressure test after maintenance could result in gas leaking inside the enclosure causing a hazard or damaging the equipment.

After any maintenance operations in this section are performed, the system must be pressure tested to ensure it is leak free.

In addition, a pressure test should be performed as part of routine maintenance. The following sections outline the required equipment, the set-up, and the procedure for the pressure test on the different systems available.



Do not open enclosure when an explosive atmosphere is present.

### Required Equipment

To perform the test procedure, the following equipment will be required:

- QED Pressure Test Kit (part number: 5015062-US)

OR

- 0-80 in.H<sub>2</sub>O (0-200mbar) pressure gauge with minimum of 4 in.H<sub>2</sub>O (10mbar) increments
- T-piece fitting suitable for tubing
- A ball valve
- Pressure application device, such as a manual pump
- Fittings and tubing to connect to the system bulkheads (1/4" OD compression, 1/4" BSPT)

**Note:** An additional three ball valves will be required if not installed on the 'process return', 'Auto-Calibration In', and 'vent to atmosphere' lines as recommended during the installation.



Do not use liquid leak detector in the BIOMETHANE 3000 system, as there are mains voltages present. This could result in an electric shock leading to injury and in some cases may be fatal.

## Operating Manual

### Diagnostics Control Mode



The BIOMETHANE 3000 includes a feature that allows the user to toggle the condition of the solenoids, relays, and pumps in the system. During the pressure system test of the BIOMETHANE 3000, the user will need to control the position of the solenoid valves in order to complete a comprehensive test. To enable diagnostics control mode:

- 1) From the 'Gas Readings Screen' press the 'Menu' key.
- 2) Press the left soft key for the 'Device Info' menu.
- 3) Press key '3' for 'Diagnostics'.
- 4) Press the 'pump' key to display 'Diagnostics Control Mode'.

Note: Entering this mode of operation will stop the sampling process.

Note: The diagnostic control mode will not be required when pressure testing the auto-calibration system.

Diagnostics				G300001	
Id	Pump	Relay	Solenoid	4-20mA Out	4-20mA In
1	<input type="checkbox"/> OFF	<input type="checkbox"/> OFF	<input type="checkbox"/> OFF	0.00	4.50
2	<input checked="" type="checkbox"/> ON	<input type="checkbox"/> OFF	<input type="checkbox"/> OFF	0.00	
3	<input type="checkbox"/> OFF	<input checked="" type="checkbox"/> ON	<input type="checkbox"/> OFF	0.00	
4		<input type="checkbox"/> OFF	<input type="checkbox"/> OFF	0.00	
5		<input type="checkbox"/> OFF	<input type="checkbox"/> OFF	0.00	
6		<input checked="" type="checkbox"/> ON	<input checked="" type="checkbox"/> ON	0.00	
7		<input type="checkbox"/> OFF			
8		<input type="checkbox"/> OFF			

 **Exit**
v0.0.0 

Screen 53 – Diagnostics Control Mode

- 5) Using the scroll keys, navigate to the desired parameter. Pressing the  $\leftarrow$  key will toggle the status of the hardware item between on and off.
- 6) Pressing the right soft key at any point will return the user to the 'Device Info' menu.

Note: When returning to the 'Gas Readings Screen' after being in diagnostics control mode, the sampling process will start from the beginning.

# Operating Manual

## General Set-Up

### BIOMETHANE 3000 System

The image below shows an example of how the equipment will look when performing the test procedure.

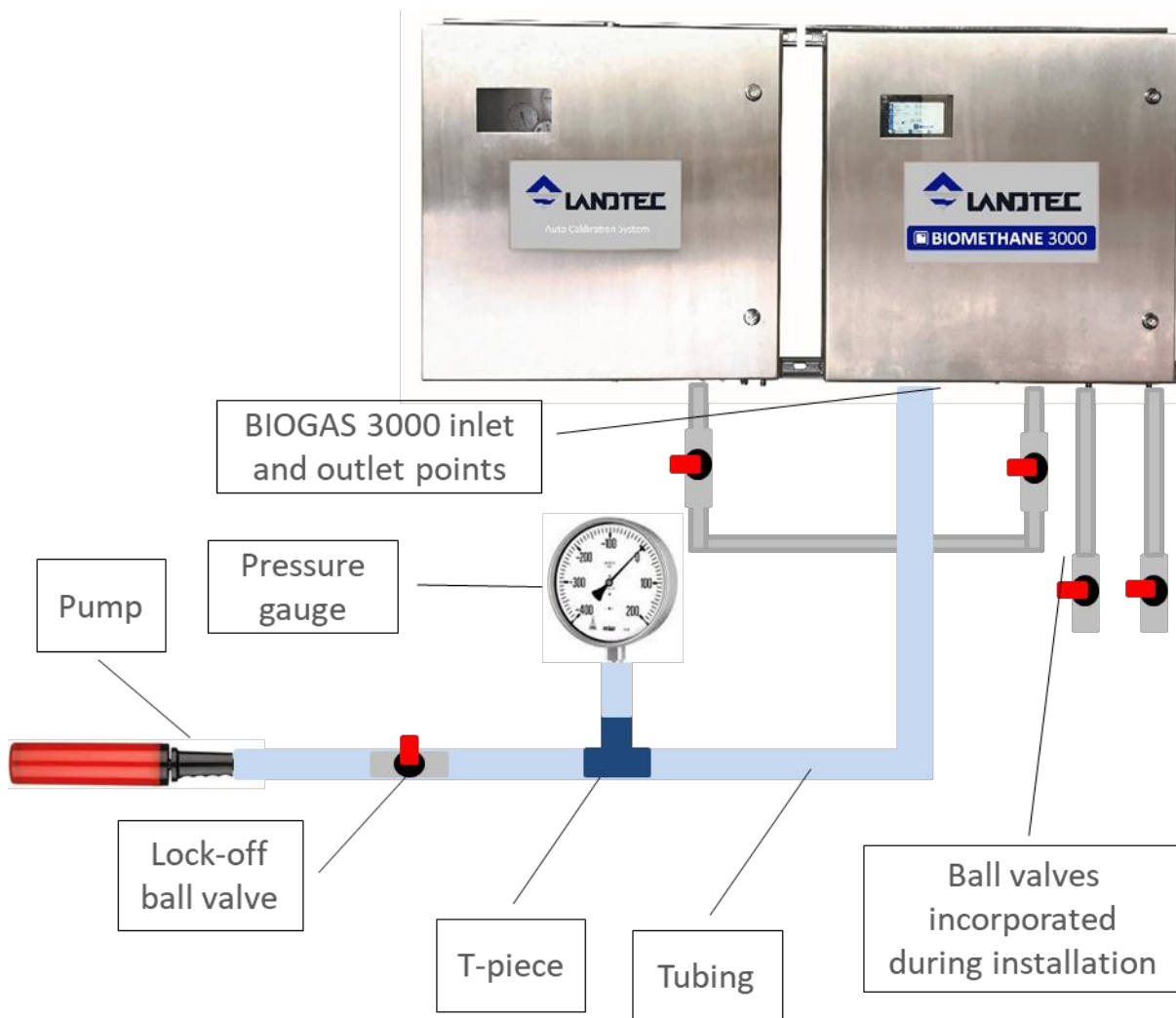

### Auto-Calibration System

There are no set-up requirements for the auto-calibration system pressure test.

## Performing the Pressure Test

- Note: Any identified leaks will need rectifying prior to the BIOMETHANE 3000 and Auto-Calibration system being used.
- Note: Ensure all gas in and gas out ball valves are opened once testing is completed.
- Note: When reattaching the sample pipes to the system, ensure all tube connections are tight and free from leaks using the liquid leak detector.
- Note: If assistance is required, please contact your local distributor, or our technical support team at QED at (800) 624-2026 or email [service@qedenv.com](mailto:service@qedenv.com).

# Operating Manual

## BIOMETHANE 3000 System



Do not open when an explosive atmosphere is present.  
 Ensure the gas supply has been isolated at the source before disconnecting the tubing from the equipment.

The test is to apply 40in.H<sub>2</sub>O (100mbar) of pressure to each gas inlet, in turn as per the table associated to the model types below. Solenoids are to be toggled via the [Diagnostic Control Mode](#).

A successful test is a pressure drop of less than 4in.H<sub>2</sub>O (10mbar) in a minute on each test point.

For each test, the ball valves on the 'Process Return' and 'Vent to Atmosphere' lines should be closed.

**Note:** Ensure the drain valve is closed when performing the pressure test.

**Note:** An additional two ball valves will be required if not installed on the 'Process Return' and 'Vent to Atmosphere' outlets as recommended during the installation.

### No External Sensor

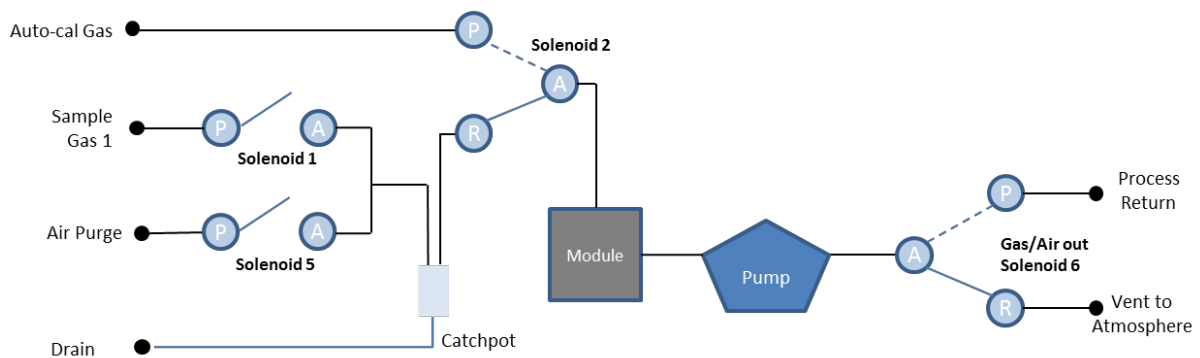

Apply pressure to:	Solenoid 1	Solenoid 2	Solenoid 5	Solenoid 6
Air Purge	OFF	OFF	OFF	OFF
Sample Gas 1	ON	OFF	OFF	ON
Auto-cal Gas	OFF	ON	OFF	OFF

# Operating Manual

## With an External Sensor

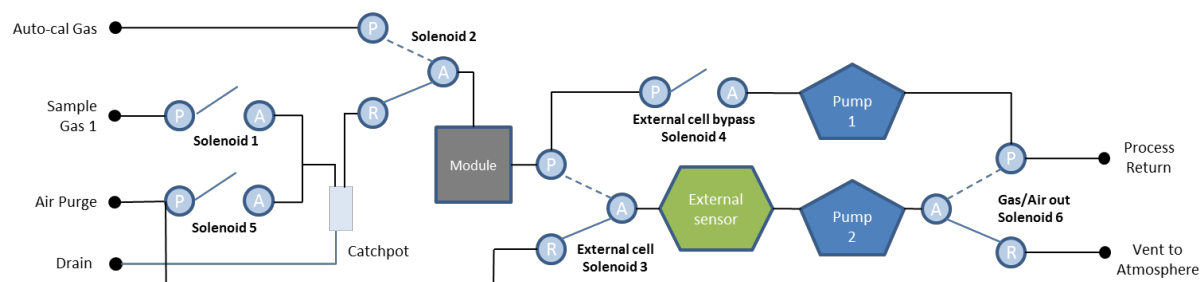

Apply pressure to:	Solenoid 1	Solenoid 2	Solenoid 3	Solenoid 4	Solenoid 5	Solenoid 6
Air Purge	OFF	OFF	OFF	OFF	OFF	OFF
Sample Gas 1	ON	OFF	OFF	ON	OFF	OFF
Auto-cal Gas	OFF	OFF	OFF	OFF	OFF	OFF

## Auto-Calibration System



This test involves the operator using a liquid leak detection fluid to check gas fittings that could be at high pressure and therefore great care must be observed. If in doubt, please contact a specialist or our technical support team at QED at (800) 624-2026 or email [service@qedenv.com](mailto:service@qedenv.com).

- Ensure the auto-calibration gas cylinder is turned on and the system is pressurized.
- Apply the liquid leak detection fluid to all compression fittings.
- A successful test is no sustained bubbles present on the compression fittings.
- Once complete, dry fittings with a cloth.

### Setting the Auto-Calibration Pressure Regulator

Refer to [Fitting/Replacing the Disposable Gas Cylinder](#).

### Cleaning and Decontamination

The equipment must be isolated from the mains supply prior to cleaning or decontamination. The enclosures can be cleaned externally using a mild soapy water and non-abrasive cloth.

Should the need arise for the BIOMETHANE 3000 module to be returned for service, it is the responsibility of the owner to ensure that the module has been decontaminated or that QED has been made aware of any contaminants that may be present, prior to it being returned.



Only the exterior of the enclosure should require cleaning. Cleaning the interior could result in injury due to mains power being present.  
High-pressure jet washers should not be used to clean the enclosure.

## Operating Manual

### SERVICE

#### General

The BIOMETHANE 3000 module should be regularly serviced to ensure correct and accurate operation. QED recommends a service and recalibration every **12 months**.

It is recommended that only qualified engineers service the BIOMETHANE 3000 module. Failure to observe this will result in the warranty becoming invalid.

**Note:** For further information on how to return your BIOMETHANE 3000 module for service, please contact your distributor or our service team at QED at (800) 624-2026 or email [service@qedenv.com](mailto:service@qedenv.com).

#### Service Notifications

The BIOMETHANE 3000 uses two icons on the 'Gas Readings Screen' to notify the user that the module is due a service:



The service is due in 28 days



The service is overdue

In addition to the icons on screen, the service due date is a readable parameter in the Modbus, Profibus, Profinet, and Ethernet registers, and is viewable in the [System Information](#) screen.

#### Replacement BIOMETHANE 3000 Module for Service – Hot Swap





The BIOMETHANE 3000 has been designed to avoid unnecessary downtime and a temporary BIOMETHANE 3000 module can be supplied during service upon request. Below are instructions on how to swap out the BIOMETHANE 3000 module for service.

Do not open when an explosive atmosphere is present.



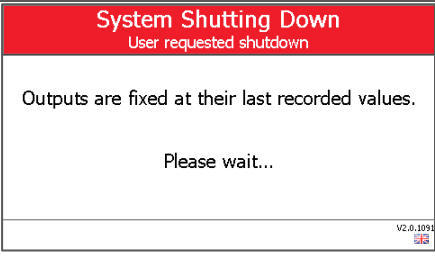

Mains voltages are present within the BIOMETHANE 3000 system and great care needs to be observed. If there is any uncertainty, seek advice from a professional or isolate the supply. Alternatively, contact your local distributor, or our technical support team at QED at (800) 624-2026 or email [service@qedenv.com](mailto:service@qedenv.com) to arrange a site visit. (Please note a charge may be applicable.)

Operating Manual

Op.	Image	Instruction
1		<p>Power off the module by holding the on/off key for two seconds.</p> <p><b>Note: This will freeze the outputs at their last known value.</b></p>
2		<p>Disconnect the gas inlet and gas outlet tubing from the top of the BIOMETHANE 3000 module.</p>
3		<p>Disconnect the USB lead from the communications connector and the power supply lead from the power supply connector from the top of the BIOMETHANE 3000 module.</p>
4		<p>Remove the four screws securing the module mounting brackets to the pillars using a 4mm Allen key.</p> <p><b>Note: Keep the screws safe, as they will be required to secure the hot swap module.</b></p>
5	<p>No image</p>	<p>Send the module to your distributor or our service team at QED.</p>
6		<p>Align the new module with the four pillars and secure in place using the four screws and 4mm Allen key. The screws must be tightened to 4 N·m.</p>

Operating Manual

 It is critical that the screws are torqued to 4 N.m. Failure to tighten to this setting will invalidate the ATEX and IECEx certification.

7		<p>Reconnect the USB lead to the communications connector and the power supply lead to the power supply connector at the top of the BIOMETHANE 3000 module.</p>
8		<p>Reconnect the gas in and gas out tubing to the module.</p> <p><b>Note:</b> The yellow tubing should connect to the yellow port on the module.</p> <p><b>Note:</b> Ensure that the couplings are fully pushed into the housing.</p>

 It is critical that the connections are fully secured to ensure that no gas leaks in to the main enclosure. It is recommended that a [Pressure Test](#) be completed to ensure the system is leak free.

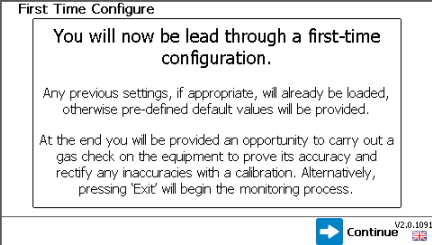
9		<p>Power on the module by pressing the on/off key for two seconds.</p>
10		<p>The hot swap module will pre-load the configuration from the Interface PCB and run the operator through a <a href="#">First Time Configuration</a>.</p>

**Note:** After replacing the BIOMETHANE 3000 module, QED recommend that a gas check be performed on the system to ensure it is still reading accurately. If required, a user calibration can also be performed; refer to the [Gas Check and Calibration](#) section of this operating manual for more information.



## Operating Manual

### PROBLEM SOLVING

This section discusses various problems that may be encountered, and warnings or error messages that the operator may receive during general operation of the BIOMETHANE 3000. For further assistance please contact your local distributor, or our technical support team at QED at (800) 624-2026 or email [service@qedenv.com](mailto:service@qedenv.com).

#### Fault Detection

When switched on the instrument will perform a pre-determined self-test sequence taking approximately sixty seconds. During this time, many of the systems working parameters and settings are checked. In addition, during normal operation, similar parameters are checked to ensure the channels are valid.

There are two types of faults, critical and non-critical.

#### Non-Critical Faults

If a non-critical fault is detected after power on, a warning will be displayed in a summary screen:



Screen 54 - Self-test with warnings

For non-critical faults at this stage, the user can continue by pressing the right soft key 'Continue'. The BIOMETHANE 3000 will continue automatically after thirty seconds if continue is not pressed.

In addition to [Screen 54 - Self-test with warnings](#), there will be a non-critical fault icon present on the 'Gas Readings Screen' during monitoring:



A non-critical fault does not stop the sampling process and this will continue as normal. Examples of non-critical faults are a channel under-ranging or the service being due.

Pressing the right soft key on the 'Gas Readings Screen' will display the non-critical faults the system has detected.

Operating Manual

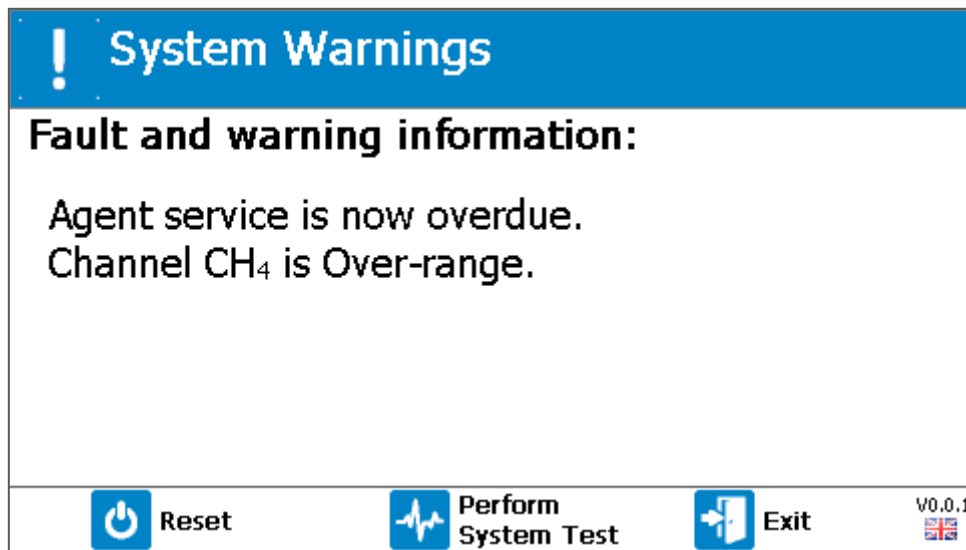

Screen 55 - System Warnings (non-critical faults)

From this screen:

- pressing the left soft key will 'Reset' the system and power cycle the BIOMETHANE 3000 module
- pressing the middle soft key will perform a system test. If the fault clears after this, monitoring will resume and the icon will be removed
- pressing the right soft key will 'Exit' and returns the operator to the 'Gas Readings Screen'.

Critical Faults

If a critical fault is detected after power on or during normal operation, a warning will be displayed in a summary screen:

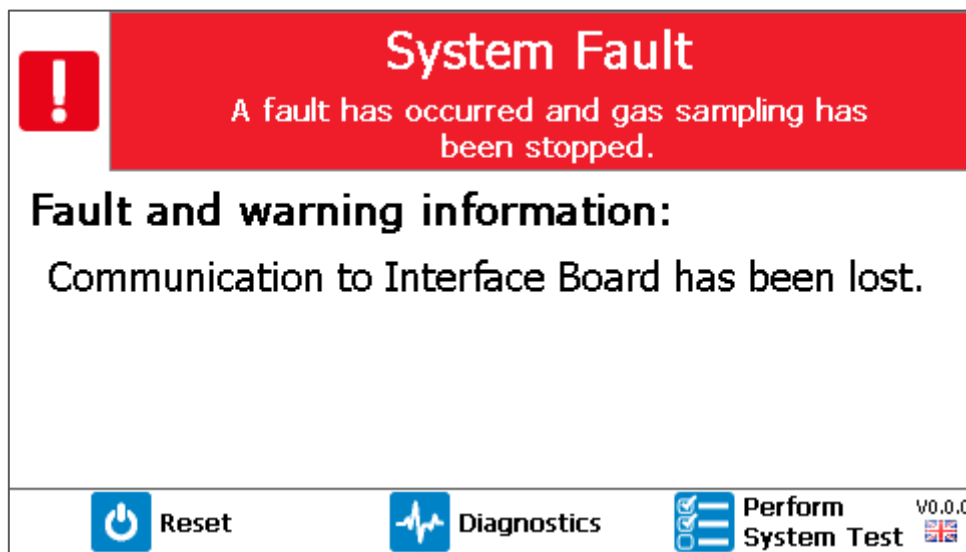

Screen 56 - System Fault

The difference between a non-critical fault and critical fault is that the user cannot proceed until the fault is rectified. In addition, the fault relay is de-energized to inform the operator of a problem.

## Operating Manual

Examples of critical faults are a loss of communications to the Interface PCB and low flow. If a critical fault occurs during the monitoring process, the process will be immediately stopped, the outputs will be frozen at their last known value, the fault relay will be de-energized, and an error message posted on screen.

From this screen:

- pressing the left soft key will 'Reset' the system and power cycle the BIOMETHANE 3000 module
- pressing the middle soft key will access the 'Diagnostics' screen. This may be required if seeking technical support
- pressing the right soft key will perform a system test. If the fault clears after this, monitoring will resume, the message will be cleared, and the fault relay energized.

After a critical fault occurs, the system will perform a self-test every fifteen minutes on four occasions to check if the fault has cleared. In the event it is still present, the self-test will then occur every 24-hours until user intervention or the fault has cleared.

### System Will Not Power On

Ensure the switched mains supply is turned on and check that the LEDs are illuminated on the 24Vdc and 12Vdc power supplies. If they are not, check the mains fuse (fuse 1) and replace if necessary.



Do not remove fuses when energized.

If the problem persists, please contact your local distributor, or our technical support team at QED at (800) 624-2026 or email [service@qedenv.com](mailto:service@qedenv.com).

### Module Will Not Power On

Ensure there is power to the system by checking that the LEDs are illuminated on the 24Vdc and 12Vdc power supplies. If they are not, check the mains fuse (fuse 1) and replace if necessary.

If they are illuminating, it can take up to one minute for the BIOMETHANE 3000 module to power on. If it does not turn on at the point power to the system is applied, please wait one minute before pressing any keys on the module.

If after one minute the module has not powered on, check the fuse for the supply to the module (fuse 2) and replace if necessary.

Finally, check fuse 3, which provides 12Vdc to the Interface PCB, which in turn supplies the power to the module.



Do not remove fuses when energized.

If the problem persists, please contact your local distributor, or our technical support team at QED at (800) 624-2026 or email [service@qedenv.com](mailto:service@qedenv.com).

## Operating Manual

### Module Lock-Up

In the rare event that the BIOMETHANE 3000 'locks up' and will not recognize button presses, the system should automatically power cycle the module due to a loss of communications.

If this does not occur or fix the problem, isolate the supply to the system and leave the system switched off for 60 seconds. After this duration, turn the power back on and check the systems operation.

If the problem persists, please contact your local distributor, or our technical support team at QED at (800) 624-2026 or email [service@qedenv.com](mailto:service@qedenv.com).

### Under and Over Range Codes

If a reading is under range (i.e. below zero) it will display 'less than' chevrons (<<<). This can occur if:

- a channel has been incorrectly user calibrated
- the BIOMETHANE 3000 module has been damaged (e.g. during transit)
- the BIOMETHANE 3000 module has drifted out of calibration or it is due a factory calibration.

If a reading is over range (i.e. above the maximum allowed value), it will display 'more than' chevrons (>>>). This can occur:

- for the same reasons as an under range error
- if the channel is reading more than its acceptable limit (e.g. CH<sub>4</sub> > 100%)
- due to potential cross gas effects.

**Note: The BIOMETHANE 3000 CH<sub>4</sub> channel will have a cross gas effect with propane. Propane will make the channel read higher than expected and therefore, all necessary precautions should be taken to avoid propane being in the sample gas.**

In most circumstances, a return to factory settings (see [Restore to Factory](#)) and performing a user calibration (see [Gas Check and Calibration](#)) will resolve the error. If the error is not cleared by performing these tasks, please contact your local distributor, or our technical support team at QED at (800) 624-2026 or email [service@qedenv.com](mailto:service@qedenv.com).

### Analog Outputs Not Working

Please refer to section [4-20mA Outputs](#) in this operating manual to ensure the outputs have been wired correctly. If the wiring method is not suitable for the input systems configuration, please contact your local distributor, or our technical support team at QED at (800) 624-2026 or email [service@qedenv.com](mailto:service@qedenv.com).

If the system is wired correctly, ensure the analog outputs have been configured correctly; refer to [Configure Analog Outputs](#) for more information.

Check that your 4-20mA input channel is being interpreted correctly; refer to [4-20mA Scaling](#).

Finally, check fuse 5, which is used to provide power to the 4-20mA loop.

If the problem persists, please contact your local distributor, or our technical support team at QED at

## Operating Manual

(800) 624-2026 or email [service@qedenv.com](mailto:service@qedenv.com).

### Modbus Outputs Not Working

Please refer to section [Configure Modbus Slave](#) in this operating manual and ensure that the configuration of the Modbus port is correct and that the wiring is correct as per [Wiring Diagram 3 – Modbus](#).

**Note:** If the BIOMETHANE 3000 is first or last on the bus, ensure the termination is set to 'On'. Likewise, if it is not, ensure the termination is set to 'Off'.

In addition, also check that no two nodes on the bus have the same slave address. If this is the case, the BIOMETHANE 3000 slave address can be changed by referring to section [Configure Modbus Slave](#) in this operating manual.

If the problem persists, please contact your local distributor, or our technical support team at QED at (800) 624-2026 or email [service@qedenv.com](mailto:service@qedenv.com).

### Low Flow / Flow Fail

If a flow fail occurs, this is classified as a critical fault and sampling will be stopped.

A flow fail occurs when there is not enough gas flowing through the BIOMETHANE 3000 module. This can be for a number of reasons:

- You are sampling against a vacuum outside of the range of the system
- There are blockages in the system
- There is a gas leak in the system.

Firstly, check that all gas in and gas out valves are open, the drain valve is closed, and the calibration valve is closed.

If the pump has been configured to off, ensure there is enough pressure in the sample for a reading to be taken. If required, set the pump to on in the [Configure Pump](#) menu option.

If the valves are in the correct position, there is enough pressure for the sample to be taken, and the problem persists:

- Ensure that the system is not operating against a vacuum outside of its operating range. Refer to the latest technical specification (available at [www.qedenv.com](http://www.qedenv.com)) for further information.
- Empty the catchpot of any contents (see [Emptying the Catchpot](#)).
- Replace inline PTFE filter (see [Replacing the Inline PTFE Filter](#)).
- Replace the catchpot filter (see [Replacing the Catchpot Filter](#)).
- Visually check for damaged pipes or obvious signs of leaks.
- Perform a [Pressure Test](#).
- Retest the system.

If after performing the above steps the problem is still present, please contact your local distributor,

## Operating Manual

or our technical support team at QED at (800) 624-2026 or email [service@qedenv.com](mailto:service@qedenv.com).

### Fuses



The use of alternative fuses may affect the safety of the apparatus and will invalidate the hazardous area certification.

Ensure the power is isolated before removing the [Protective Cover](#) and replacing fuses. Once replaced, the protective cover will need to be refitted.

Please refer to the following table for the designation and location of each fuse together with its type and rating:

Designation	Circuit	Rated voltage	Rated current	Type
FS1	Mains input Power supplies Heater	250v	3.15A	20mm time delay, ceramic
FS2	24Vdc pumps Drain pump Reed switch	250v	1.25A	20mm time delay, ceramic
FS3	4-20mA loop Relay control External sensor	250v	500mA	20mm time delay, ceramic
FS4	Solenoids	250V	1A	20mm time delay, ceramic
FS5	24Vdc supply	250V	2A	20mm time delay, ceramic
FS6	BIOMETHANE 3000 module supply	250v	1A	20mm time delay, ceramic
FS7	12Vdc supply to Interface PCB	250V	1A	20mm time delay, ceramic

Note: Please contact your local distributor, or our sales team at QED at (800) 624-2026 or email [service@qedenv.com](mailto:service@qedenv.com) for further information.

# Operating Manual

## User Calibration Explained

### General

User calibration is a means of optimizing the performance of the BIOMETHANE 3000 system to the current operating conditions such as temperature and pressure as well as correcting for analyzer drift caused by the infrared source.

User calibration has two operations, zero and span, and each may be performed individually. However, for a complete user calibration both must be completed. The BIOMETHANE 3000 can perform a user calibration at the request of the user via the [Gas Check](#) screen or at set frequencies via the [Auto-Calibration Settings](#) screen.

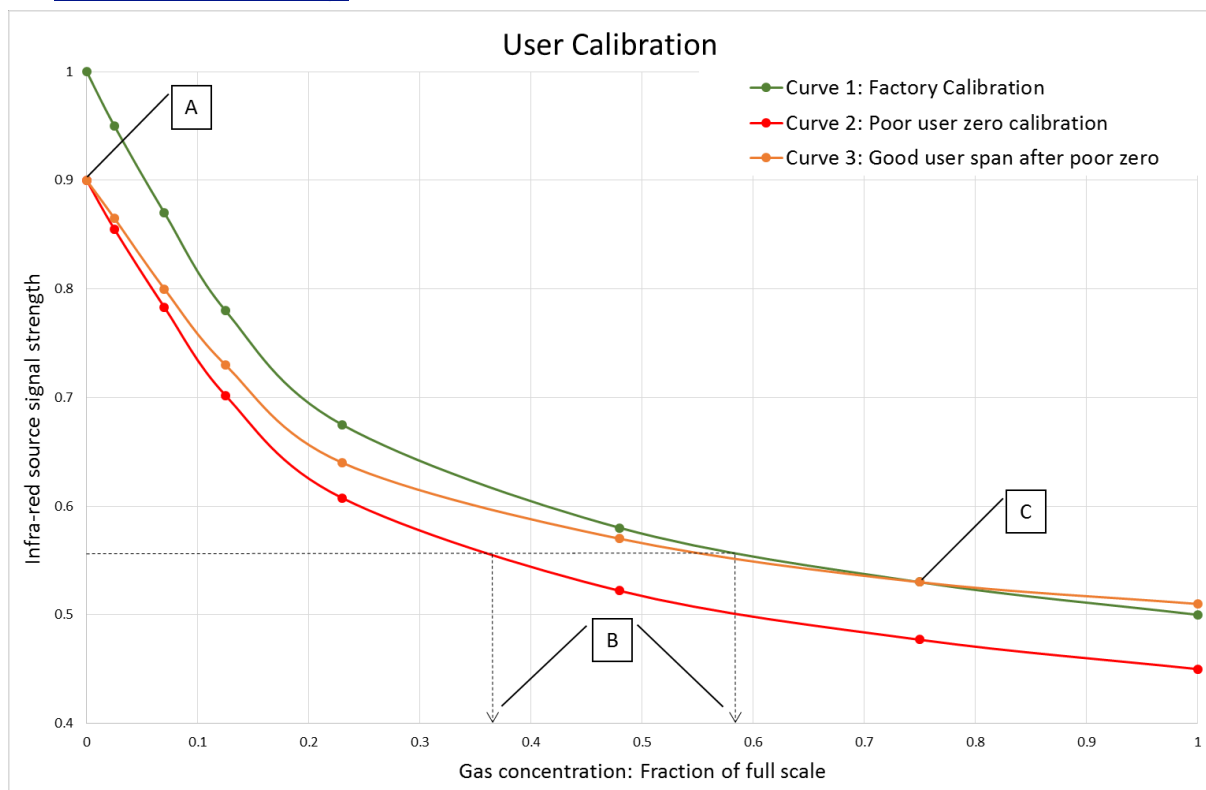

Graph 1 - User calibration explained

### Factory Calibration

When the BIOMETHANE 3000 module is factory calibrated, a stable gas curve is generated (see curve 1 on [Graph 1 - User calibration explained](#)). This curve is then used to determine the gas concentration based on the infrared signal strength after being absorbed by the gas.

### User Zero Calibration

A zero calibration is used to correct the entire curve for the infrared source and filter variations caused by aging and induced drift due to dirt and other contaminants. If done correctly, there is often no need to complete a span calibration, as the new curve will follow closely to the factory calibration curve (curve 1 on [Graph 1 - User calibration explained](#)).

The zero calibration is very sensitive and a rushed or poor calibration, (such as the target gas still

## Operating Manual

being present), will result in a zero error; see point A on curve 2 of [Graph 1 - User calibration explained](#). This also produces an error throughout the remainder of the curve proportional to signal strength, but the effect on the span is significant, see point B on [Graph 1 - User calibration explained](#).

**Note:** To perform an accurate user calibration it is critical that a good user zero has been performed. QED recommend that this be done in nitrogen in order to guarantee that none of the gas of interest is present.

**Note:** To obtain a good zero it may be necessary to flow nitrogen for several minutes, especially if the BIOMETHANE 3000 system has been subjected to high levels of gas previously, in order to ensure there are no remains of the target gas present. On the BIOMETHANE 3000, this would result in leaving the system for several minutes before pressing 'check' during the gas check process.

### User Span Calibration

A span calibration is used to optimize the analyzer at the span calibration concentration (see point C on [Graph 1 - User calibration explained](#)) for the current operational conditions. It corrects the span point but leaves the zero unadjusted (this will be left at the last user zero if this has been performed) and should be done at the concentration of interest in the particular application.

If the user zero is poor and the span calibration is good, it will correct the gas curve for the point of interest, but other points on the curve could be incorrect, see curve 3 on [Graph 1 - User calibration explained](#).

### Trouble Shooting

#### User Zero Calibration Failed

Three possible reasons for this are that:

- the BIOMETHANE 3000 module is trying to zero to a level which is outside the predetermined range set when the module was last factory calibrated
- the gas is not stable i.e. it is still purging out the measured gas
- the system is not seeing a flow of gas.

To rectify this:

- ensure the BIOMETHANE 3000 module contains none of the gas that is being zeroed by flushing through with nitrogen, or clean ambient air if this is not available and repeat a user zero calibration
- ensure the correct zero calibration has been selected (nitrogen, fresh air, or a mix with none of the target gas present) and retry
- ensure the flow regulator on the gas bottle is open (if being used).

If after performing the above steps the problem is still present, please contact your local distributor, or our technical support team at QED at (800) 624-2026 or email [service@qedenv.com](mailto:service@qedenv.com).



## Operating Manual

### User Span Calibration Failed

Check the following:

- the span target (see [Gas Mixtures](#)) is set to the value given on the calibration bottle. If not, correct and re-span the channel
- the flow regulator on the gas bottle is open and there is a good flow rate on the flow meter
- there is gas in the auto-calibration cylinder
- there is an adequate flow of gas to the system (see annotation 2 on [Figure 3 – Auto-Calibration internal components](#))
- sample duration for the auto-calibration settings are suitable for providing a stable reading.

If the problem persists, repeat an entire user calibration by zeroing the channel prior to performing a span calibration.

**Note:** Always ensure that the on-screen reading has begun to stabilize before pressing 'Check'. If you notice that the reading is still changing after the elapsed time, use the 'Retry' function and perform the span calibration again.

If after performing the above steps the problem is still present, please contact your local distributor or our technical support team at QED at (800) 624-2026 or email [service@qedenv.com](mailto:service@qedenv.com).

### Channel Outside of Limits

A channel outside of its limits to be calibrated is indicated by the  icon in the 'User Calibration' screen. The cause of this is either:

- The channel is under-ranging or over-ranging
- The current user reading is too far from the target

In both scenarios, perform a [Restore to Factory](#), followed by a zero or span check.

If after performing the above steps the problem is still present, please contact your local distributor, or our technical support team at QED at (800) 624-2026 or email [service@qedenv.com](mailto:service@qedenv.com).

### CH4 Reading Low and O2 Reading High

If you believe that the CH4 reading is lower than you expect or the O2 reading is higher than you expect, there could be two reasons for this:

- There could be a leak in the tubing and when sampling you could be drawing in air and diluting the sample. Refer to the [Pressure Test](#) section of this operating manual for instructions on how to pressure test the BIOMETHANE 3000 system.
- The BIOMETHANE 3000 has drifted since its calibration and may be due a user calibration; see section [Gas Check and Calibration](#) of this operating manual for further information.

If after performing the above steps the problem is still present, please contact your local distributor, or our technical support team at QED at (800) 624-2026 or email [service@qedenv.com](mailto:service@qedenv.com).

## Operating Manual

## BIOMETHANE 3000 WARRANTY TERMS AND CONDITIONS



## BIOMETHANE 3000 Warranty Terms and Conditions

QED will repair or replace (at QED's discretion) any goods supplied by the company in respect to defects arising within **12 months** for components related to the system and **3 years** for components related to the module from date of purchase or delivery, whichever is later, provided that:

- The defect is due to faulty parts or workmanship provided by QED.
- Proof of delivery/purchase must be provided to QED for any claims. This includes a QED sales order, invoice, or delivery confirmation.
- All warranty repairs can only be carried out by QED or its authorized agents. In certain circumstances, permission may be granted by QED for the owner to replace a supplied part under warranty.
- Any repair or replacement component under warranty will not extend the warranty period of the system.
- Products must have been returned for service and calibration as recommended by QED or its authorized agents.
- Where replacement parts have been supplied by QED under warranty, the replaced parts must be returned to QED. If not returned, QED reserves the right to charge for the replacement part.
- If no fault is found an investigation charge may apply.
- QED's Technical support **MUST** be notified in the event of a pending warranty claim. They will then issue a return authorization number that must be included with any return. Failure to provide this will void any warranty claim.

**The following is not included:**

- Normal wear and tear of parts that might wear out over time, or be consumed, is not covered. Parts not covered include, but are not limited to, the suppression diodes, PTFE filter, coalescing filter, electrochemical cells, and tubing.
- A service, such as instrument calibration, is not part of a warranty claim.
- Accidental damage, including dropping during installation.
- Damage as a result of vandalism.
- Faults arising from use of the equipment that is not in accordance with standard operating procedures laid out in QED's operating manual.
- Faults arising from use of the equipment in unsuitable applications.
- Repairs or alterations carried out by parties other than QED, its authorized agents, or under the instruction of QED.
- Any data stored on the equipment that may be lost.
- A claim due to a failure in maintaining the system in accordance with the operating manual.
- A claim as a result of poor quality or inadequate repairs.
- Any business-related losses such as income, profits, and contracts (as far as the law allows).

**The following voids the warranty:**

- When non-approved QED parts have been used for repair or maintenance.
- When parts are added, or alterations made, to the system outside the scope of the operating manual.

[www.qedenv.com](http://www.qedenv.com)

BM3000WARRANTY-L Iss.01  
© QED Environmental Systems, Inc.

## Operating Manual



BIOMETHANE 3000 Warranty Terms and Conditions

Page 2 of 2

- The BIOMETHANE 3000 module has been opened, unless by QED approved service centers (where applicable).
- The BIOMETHANE 3000 system and/or auto-calibration system has been opened in poor weather conditions that have resulted in damage to any of its components.
- The equipment has been stored or installed outside of the operating range and environmental conditions determined in the operating manual.
- The equipment has not been maintained in accordance with the operating manual.

#### Service Warranty:

- QED offers a three-month warranty period, following a QED service, to cover any defects that have arisen because of that service.



#### Note

Warranty repair is only granted after an investigation by QED.

For assistance in determining if your equipment qualifies for warranty investigation, please contact our technical support team at (800) 968-2026 or email [landtec\\_support@qedenv.com](mailto:landtec_support@qedenv.com).

For any other queries please contact our sales team at (800) 624-2026 or email [info@qedenv.com](mailto:info@qedenv.com).

QED Environmental Systems reserve the right to update these terms and conditions without notice.

Operating Manual

**GLOSSARY OF TERMS**

Term	Definition
Air purge	Process used to clear out gas from the tubing within the BIOMETHANE 3000 system and used as part of a user zero in air.
Baro	The atmospheric pressure at the given location, measured in milli bar (mb/mbar).
CH <sub>4</sub>	Methane
CO <sub>2</sub>	Carbon dioxide
CO	Carbon monoxide
Catchpot filter	The filter used to drop water droplets from the sample gas into the catchpot.
Current source	The BIOMETHANE 3000 supplies the source to the 4-20mA loop. Other configurations are available.
Electrochemical gas sensor	A method of gas detection that works based on a chemical reaction with the target gas e.g. H <sub>2</sub> S.
External gas sensor	An electrochemical gas sensor incorporated in to an assembly external to the BIOMETHANE 3000 module but part of the overall system. It allows an additional gas to be monitored by the equipment.
Factory settings	Default settings pre-set at time of manufacture or service.
Firmware	Firmware is the term by which the internal module software is known and is not accessible by the client. Firmware is updated to the latest version when the analyzer is returned to QED or an approved agent for servicing. The firmware can be updated by the end user using a QED approved power source and the Landtec Firmware Updater.
H <sub>2</sub>	Hydrogen
H <sub>2</sub> S	Hydrogen sulphide
Hazard	A potential source of harm.
Hazardous live	Capable of rendering an electric shock or electric burn.
Infrared source	The component used to provide a source of infrared light that can be absorbed by the gas.
Infrared source drift	The component used to provide a source of infrared light has changed its brightness, and may not have been fully compensated by the reference channel. This may be due to age or contamination.
Inline PTFE filter	The component used to help protect the BIOMETHANE 3000 module from water ingress.
Material safety data sheet or safety data sheet	A document that contains information about a particular substance. Commonly known as MSDS or SDS.
Modbus	Modbus is a serial communications protocol and is a means of connecting industrial electronic devices.
Pollution Degree 3	Conductive pollution occurs, or dry, non-conductive pollution occurs which becomes conductive due to condensation which is expected.
Polymeric materials	Organic material, natural or synthetic, with high molecular weight made of repetitive structural units. Examples include wool and PVC.
Pump	Used to draw the gas sample from the monitoring point to the BIOMETHANE 3000.
Reference channel	An infrared channel that has no sensitivity to the gas of interest that is used as a baseline for the CH <sub>4</sub> and CO <sub>2</sub> absorption.